

Monthly adventure role-playing aid

# Dragon®

\$3.00

#86

Build your own castle  
Special friends for M-U's  
Guide to super-bad guys





# Create The Masterpiece Of Your Imagination.



02-925 RANGERS  
1 OF 3



02-922 GNOMES  
2 OF 4



02-921 NON-HUMAN  
WARRIOR THIEVES  
3 OF 4



## All Things Dark and Dangerous Available in March.

02-921	Non-Human Warrior Thieves (4)	4.00
02-922	Gnomes (4)	3.50
02-923	Chimera	3.50
02-924	Mage, mounted and on foot	4.00
02-925	Rangers (3)	3.50

## The Best of Ral Partha Available in March.

10-304	Dungeon Fiends (00)	8.00
10-305	Adventure Fellowship (00)	8.00
10-306	Fantasy Champions (00)	8.00
10-307	Mystic Masters (00)	8.00

- All Things Dark and Dangerous sculpted by Julie Guffrie.
- Figures are not necessarily shown actual size.
- Some assembly may be required.

This month's Ral Partha Masterpiece is THE ELF CHARIOT (code #02-020, \$10.00 retail), sculpted by Tom Meier and painted by Bob Hodges. If you want to paint your own Chariot Masterpiece we will send you free, detailed painting instructions.

For your free painting instructions for THE ELF CHARIOT, send a self addressed, stamped envelope to:

Ral Partha Enterprises  
Dept: Chariot  
5938 Carthage Court  
Cincinnati, Ohio 45212





# DISCOVER THE ACTION PACKED WORLD OF LOREMASTER WITH CAMPAIGN AND ADVENTURE MODULES FROM IRON CROWN ENTERPRISES

The Loremaster modules depict an exciting new fantasy world. They are specifically designed for our Rolemaster system but can be used with other fantasy role-playing systems.

## THE CLOUDLORDS OF TANARA™

Discover the secret of these demigods who attempt to control the kingdom of TANARA.

## THE WORLD OF VOG MUR™

This isolated volcanic island group is ruled by half-elven lords and their evil KRAL raiders.

## THE SHADE OF THE SINKING PLAIN™

While seeking immortality a powerful Sorceress becomes trapped in the twilight world of the Undead.

## THE IRON WIND™

From the frozen north of the continent of JAIMAN extends the dreaded arm of

the Unlife. Those who dare adventure here must face the awesome servants of THE IRON WIND.



IRON CROWN ENTERPRISES, INC.

P.O. BOX 1605

CHARLOTTESVILLE, VIRGINIA 22902



NAME \_\_\_\_\_

STREET \_\_\_\_\_

(IF P.O., RR, OR RFD, INCLUDE PHONE #)

CITY \_\_\_\_\_ STATE \_\_\_\_\_ ZIP \_\_\_\_\_

PLEASE RUSH ME:

- THE CLOUDLORDS OF TANARA ... \$10.00
- THE WORLD OF VOG MUR ..... \$ 6.00
- THE SHADE OF THE SINKING PLAIN \$10.00
- THE IRON WIND ..... \$ 8.00
- ROLEMASTER The complete FRP system  
in one box ..... \$38.00

All shipments within U.S. Postpaid; Canadians Add \$2.50; in Australia contact JEDKO Games 03 580-9955

# Contents

Vol. IX, No. 1

June 1984

## SPECIAL ATTRACTION

- Great Stoney . . . . .41  
*All the parts you need to make  
a miniature cardboard castle*

## OTHER FEATURES

- The ecology of the  
slithering tracker. . . . .9  
*Don't look now, but . . .*
- Familiars with a special use . . . . .12  
*Matching pets with masters*
- The warrior alternative . . . . .24  
*DRAGONQUEST™ game variant*
- Five new enchanted objects . . . . .26  
*Magic items to surprise characters*
- Presenting the Suel pantheon . . . . .30  
*More gods for Greyhawk campaigns*
- Dragons and their deities. . . . .36  
*Clerics with breath weapons!*
- Mzee . . . . .58  
*A story about coming of age*
- ORIGINS 84 preview . . . . .88

## REGULAR OFFERINGS

- Out on a Limb . . . . .3  
*Letters and answers*
- The forum . . . . .6  
*Opinions and observations*
- Index to advertisers . . . . .34
- Game reviews:  
*Battlesuit* . . . . .64  
*Phantasy Conclave* . . . . .65
- The ARES™ Section. . . . .69  
*16 pages of SF gaming articles*
- Convention calendar . . . . .86
- Gamers' Guide . . . . .90
- Wormy . . . . .92
- Dragon Mirth . . . . .93
- Snarfquest . . . . .94

**Publisher:** Mike Cook  
**Editor-in-Chief:** Kim Mohan  
**Editorial staff:** Roger Raupp  
Patrick Lucien Price  
Mary Kirchoff  
Roger Moore

**Layout designer:** Kristine L. Bartyzel  
**Subscriptions:** Melody Knull  
**Contributing Editors:** Ed Greenwood  
Katherine Kerr  
Ken Rolston

**Advertising Sales Administrator:**  
Mary Parkinson

**This issue's contributing artists:**  
Denis Beauvais Harry Quinn  
Roger Raupp Dave Trampier  
Dennis Kauth Kurt Erichsen  
Jerry Eaton Craig Smith  
Jeff Butler Larry Elmore

DRAGON® Magazine (ISSN 0279-6848) is published monthly for a subscription price of \$24 per year by Dragon Publishing, a division of TSR, Inc. The mailing address of Dragon Publishing for all material except subscription orders is P.O. Box 110, Lake Geneva WI 53147; the business telephone number is (414)248-8044.

DRAGON Magazine is available at hobby stores and bookstores throughout the United States and Canada, and through a limited number of overseas outlets. Subscription rates are as follows: \$24 for 12 issues sent to an address in the U.S., \$30 in Canada; \$50 U.S. for 12 issues sent via surface mail or \$95 for 12 issues sent via air mail to any other country. All subscription payments must be in advance, and should be sent to Dragon Publishing, P.O. Box 72089, Chicago IL 60690.

A limited quantity of certain back issues of DRAGON Magazine can be purchased from the Dungeon Hobby Shop. (See the list of available issues printed elsewhere in each magazine.) Payment in advance by check or money order must accompany all orders. Payments cannot be made through a credit card, and orders cannot be taken nor merchandise reserved by telephone. Neither an individual customer nor an institution can be billed for a subscription order or a back-issue purchase unless prior arrangements are made.

The issue of expiration for each subscription is printed on the mailing label for each subscriber's copy of the magazine. Changes of address for the delivery of subscription copies must be received at least six weeks prior to the effective date of the change in order to insure uninterrupted delivery.

All material published in DRAGON Magazine becomes the exclusive property of the publisher upon publication, unless special arrangements to the contrary are made prior to publication. DRAGON Magazine welcomes unsolicited submissions of written material and artwork; however, no responsibility for such submissions can be assumed by the publisher in any event. Any submission which is accompanied by a self-addressed, stamped envelope of sufficient size will be returned if it cannot be published.

DRAGON is a registered trademark for Dragon Publishing's monthly adventure playing aid. All rights on the contents of this publication are reserved, and nothing may be reproduced from it in whole or in part without first obtaining permission in writing from the publisher. Copyright ©1984 TSR, Inc.

Second-class postage paid at Lake Geneva, Wis., and additional mailing offices.

POSTMASTER: Send address changes to Dragon Publishing, P.O. Box 110, Lake Geneva WI 53147, USPS 318-790, ISSN 0279-6848

## On this day. . .

On this day in 1976, the first issue of DRAGON® Magazine rolled off the press. (Which day? Oh, sometime in June. When a magazine has a birthday, it lasts for a month.) Way back then, it was "The Dragon" — without the ®. It was produced by two people, and it was read by a healthy proportion of all the people who were devoted to the new hobby of fantasy role-playing.

The name is different now, and the staff is a little larger, but some things never change. DRAGON Magazine is still read by the same kind of people. The hobby isn't new any more, and a lot more people are involved in it, but the basic makeup of our readership is the same now as it was when issue #1 was a reality (try to find one these days!) and issue #86 was something that could only be envisioned with a wish spell.

Maybe that's an obvious point, but we can't take it for granted. The main reason that DRAGON Magazine has made it through eight years of continuous publication is because you've been reading what we've been printing. Whether you've been with us for 86 issues or just a few, you're invited to celebrate your own anniversary as a reader. We wouldn't be able to pat ourselves on the back for making it this far if you had not come along on the journey.

You expect a lot from us — high-quality, thought-provoking articles; artwork of similar quality; and special features that make the magazine worth having even if you don't like anything else that's in a particular issue. We try to deliver, and in return we expect a lot from you — the cash it takes to buy this magazine, the money that could be (but isn't) spent on something else instead.

This is a business, and of course we need your cash to stay alive. But we realize that in order to deserve your money, we first have to earn your support and your appreciation. On this day in 1984, what we're really celebrating is the fact that we have earned those things, and by giving us what we've earned you're making it possible for us to keep giving you what you want. That is the stuff of which good relationships are made. And it looks like this is a relationship that's going to last a while longer.

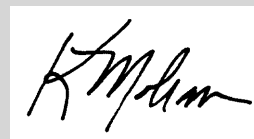





Regular readers of this space might have trouble swallowing this, but it isn't easy to keep coming up with superlatives to describe the contents of every issue of DRAGON® Magazine. Read between the lines, and you're liable to see me talking to myself with sentences like "That's going a little overboard" and "Who are you trying to kid, kid?"

Oh, but not this time. This time we *really* mean it.

We've never tried to do anything like "Great Stoney" before, but the apprehension we feel at trying something new is dwarfed by our enthusiasm for the most unusual and one of the best special inclusions we've ever offered.

It's a castle that comes in cardboard pieces that you can (you *should*) cut out and assemble, comparable in size and quality to products of the same sort that sell for more than the price of this magazine. And you also get complete instructions, background material, and floor plans so you can build Great Stoney and then use it as a feature of your fantasy role-playing campaign. We're grateful to Arthur Collins for coming up with the original plans, and to TSR's own Dennis Kauth for turning those plans into a cardboard sculpture. And if you like it, there's more where this one came from; in a few issues, we'll do it again.

In addition to the castle, which we know you weren't expecting, this issue includes some features we're pretty sure you'll like. You've been wanting new monsters, and you get a good helping of them in "Familiars with a special use" by Stephen Inniss, a sequel to his first article on familiars that we printed in #84.

You've been wanting new magic items, and "Five new enchanted objects" should fill the bill. Many of you have requested information to expand the background of the Greyhawk campaign, so this issue contains the first installment of a series in which Len Lakofka outlines the deities of the Suel pantheon. And some of you have pleaded for DRAGONQUEST™ game coverage, so we're trying to help by presenting Craig Barrett's proposal for "The warrior alternative."

In this month's ecology article, Ed Greenwood turns the spotlight on the slithering tracker. A spotlight won't necessarily make the critter any easier to see, but at least when it attacks your character, you'll understand more about what's happening.

The ARES™ Science Fiction Gaming Section covers a lot of ground in its 16 pages. James Ryan, whom we assume is not writing from personal experience, offers a guide to supervillain groups in "Know Your Enemy." Jim Ward, co-author of the GAMMA WORLD® game, describes the lunar environment in terms of that game as "A World Gone Mad." And knowing Jim, we aren't entirely sure that he *isn't* writing from personal experience. — KM



## Raise familiar?

Dear Dragon:

I was very satisfied with "A cast of strange familiars" in #84. I have one question about familiars: Can they be resurrected? If so, are the hit points restored that were lost by the M-U when the familiar was killed?

Chris Fredericks  
East McKeesport, Pa.

*Based on our interpretation of the spell descriptions for resurrection and raise dead, it isn't possible to bring a familiar back to life by these means. Those spells, and other magic of a similar nature, apparently only work on humanoid and not just any sort of creature. The raise dead text specifically lists the creature types that can benefit from the spell, implying that other types of beings cannot be raised. Depending on the DM's ruling, a wish spell might be able to bring a dead familiar back to life — but unless the wish was phrased very carefully and the DM was very generous, it wouldn't be able to get back the M-U's lost hit points. After all, the familiar did die, so the penalty should probably be applied in any case. I suppose there's the possibility of a wish that says, "put things back so the familiar never died in the first place," but that's a situation for each DM to deal with individually. — KM*

## Not the same thing

Dear Dragon:

If a character is doing battle with someone wearing a ring of lycanthropy ("Rings that do weird things," #82) and takes over half damage, can he become a lycanthrope?

Robbie Pennell  
Jenkins, Ky.

*I'd say no, even if the wearer of the ring had been permanently changed into a lycanthrope by the ring. The ring's powers come from a form of shape change or polymorph spell, not from the sort of disease/infection that's the actual cause of someone becoming a lycanthrope. — KM*

## Poison problem

Dear Editor:

The article on poisons in issue #81 was the best I've ever seen. After reading it several times, however, I came across one small mistake. In the Monster Venom chart for the poisonous toad, the chance for detecting the poison while actively searching is 40%. However, the chance to detect the poison when not actively searching is 45% — better than if one was trying to find it! Considering the price of the poison, I believe the chance for detecting it when not actively searching should be 20%. If, however, there was a typo in

the active search column, then that chance should be 90% instead of 40%.

One more thing I'd like to add. Have you ever considered publishing a listing of RPGers? I think it would be a great way to get gamers in touch with each other, and it would be invaluable to those of us in the military who are always moving. I recall that you published a similar listing in #37, so why not now?

Eric Field  
New Bern, N.C.

*Apparently Eric, you read the article on poisons one more time than we did. The error in the listing for the poisonous toad was in the original manuscript; what we published was a plain old mistake, not a typographical error. To fix it, I think your first assumption is better; a 20% chance to detect it without searching seems to be in accordance with the figures for other monster venoms given in the chart, and that's what we would have done to repair it if we had seen the mistake before you did.*

*It's a pretty sure thing that you'll never see a "listing of RPGers" in the magazine again. There are many, many more gamers — and many, many more readers of this magazine — nowadays than there were the last time we printed such a list. Even then, it was a mammoth chore to receive and catalog all the postcards from people who wanted to be listed. In this day and age, we couldn't afford the time to do all that paperwork, and even if that was possible, we couldn't spare the great number of pages it would take to print the whole list. Maybe someday we'll come up with a method and a reason for printing a big directory of gamers, but if it's ever published it won't be between the covers of DRAGON® Magazine. — KM*

## 'Disturbing trends'

Dear Editor:

Prior to issue #72, I have been an avid reader possessing naught a gripe. Two of my three players have not purchased a DRAGON in six months. I wish to express my grievances in a form of constructive criticism with the intention of producing a better magazine for all of us.

To begin with, I see no need for both the Forum and Out on a Limb. Looking at the remaining regular offerings of issue #83, I find predominantly cartoons. Is the AD&D game such a joke that we need four cartoon scripts? My players now rip open my magazine, turn to the cartoons and ignore the remainder.

Looking back to issue #57, I spy Leomund's Tiny Hut and From the Sorcerer's Scroll. Is Gary Gyax so busy that he cannot contribute an article once per year? Issues #58-62 are particularly noted for their in depth coverage of the various races. With the introduction of new races, I could foresee an infinite amount of interesting literature.

Delving into issue #83, I enjoyed "The test of



the twins" the most. It is my belief that pieces of fantasy such as this should be incorporated into every issue. Since the investigation of the mind flayer and doppelganger, I can hardly wait to turn to the ecology. Perhaps this space could be filled with monsters more interesting than the catoblepas, stirge, and piercer. I'd be ecstatic to find an ecology on the draw.

As an AD&D enthusiast, our best campaigns were staged on the World of Greyhawk. Is the World of Greyhawk non-existent? Why not explore some of the other planes? I always find articles on the middle ages highly interesting. "Who lives in that castle?" (issue #80) was an excellent article.

Enough rambling, let us breach the subject incurring the most wrath. Being a member of our school newspaper, I realize the importance of advertisements. However, 20 full page ads with a myriad of others spread throughout in a 78 page magazine is pushing it. If TSR, boasting of mammoth expansion, cannot afford to promote its product without 30%-50% of advertisements, something is seriously wrong. The greatest improvement of DRAGON has been not between the covers, but the covers themselves. I challenge you to justify the disturbing trends in the past ten magazines. Contrary to past articles where you have torn the authors apart, I believe that it would be far more difficult for you to defeat these convictions.

Tom McCarthy  
North Adams, Mass.

*Thanks for the many nice things you did say, Tom, even if some of them were like delivering a fistful of flowers with a right cross. I appreciate the compliments, but I won't dwell on them, and I don't think you expect me to argue with you about what you like.*

*As for what you don't like, let's take it from the top. You answered your own criticism about why we print so many cartoons — people like them. I pass out magazines at home every month, and I'd probably slip out on the spot if the kids did anything but turn to the cartoons first. I'm sorry that your players "ignore the remainder," but that doesn't have anything to do with the cartoons.*

*Yes, Gary Gyax is so busy. And if he could provide one column a year, we'd still get gripes from people who want two or three or twelve. I am just as sorry as you that Gary's name doesn't appear in print very often any more, but that's neither our fault nor his, and not something we can rightfully be criticized for. Your comment about coverage of "the various races" is ill-considered, because our long-ago "in depth coverage" dealt almost exclusively with player character races, and no new player character races have been created in the meantime.*

*I guess I can figure out what you mean by "more interesting" monsters as the subject of ecology articles, but I think you're missing the point of the series at the same time. You will never see an "ecology of the draw" because the dark elves are more than "just" a monster type — that's a race which has its own subculture, and which (if we ever cover it in detail) will be done in a manner much more extensive than our standard ecology presentation. For similar reasons, you will probably never see the ecology of the storm giant or the ecology of the hobgoblin, for instance. For monsters of those types, the issues that need addressing don't pertain so much to their physical makeup but instead to their society, their culture, and their status as civilizations within the AD&D game universe. It's hard to fully describe the difference without going in to cumbersome detail, but I think you can see what I mean.*

*We haven't published a lot of material for people with campaigns based in Greyhawk, I'll admit — but where was it ever written that people needed more material? If you play the Greyhawk campaign on the continent of Oerth as outlined in the WORLD OF GREYHAWK™ Fantasy Setting, you've got what you need already in that product. If you want to use that world as a foundation and modify it, you get a magazine's worth of ideas every month on how to do that. Just because an article doesn't say "Greyhawk" in it doesn't mean it can't be used by someone who runs that type of campaign.*

*For the record, we have explored other planes. And as I wrote in issue #82, we're actively seeking other manuscripts of that sort. I've been saying this for longer than most people have been reading this magazine, and it should be obvious even if you haven't read it before: We can't print what no one writes.*

*With all due respect, you can't learn the importance of advertisements by working on a school newspaper, and you can't get away with making gross assumptions about the publishing business based on that sort of experience. The revenue from advertising has helped to keep the price of this magazine at the same level for four years. The amount of space we "spend" on ads is comparable to many other magazines of the same size and circulation, and less than many others. And even with "30%-50% of advertisements," you're still getting more non-advertising material in every issue than any other gaming magazine — at an equal or lower price.*

*I don't expect that this has defeated any of your convictions, Tom; the only person who can change your mind is you. — KM*

## More facets

Dear Dragon:

I am the editor of a gem and mineral club newsletter and an avid reader of DRAGON Magazine. Needless to say, I found issue #83 a double delight. I do have a few technical remarks to make, though, concerning Michael Lowrey's "The many facets of gems."

Regarding the mystical properties, only a true stone would hold these, not those such as "oriental amethyst," "oriental emerald," or "oriental topaz." These are merely different colored varieties of carborundum. If these properties were "transferrable," those stones which had been dyed or heat-treated to alter their color would also have to be considered as talismans. For example, lapis lazuli is commonly copied by dyeing cracked quartz (called Swiss lapis) and jasper (called German lapis or blue onyx). If I were to use lapis lazuli as a talisman, I certainly wouldn't put my faith in something that wasn't "the real McCoy." Incidentally, in the jewelry trade the term "oriental" is used to denote an imitation.

Chalcedony is a fibrous, microcrystalline variety of quartz. The differences in color and banding give rise to the following: carnelian, chrysoprase, agate, onyx, and bloodstone. The red patches in bloodstone are jasper (granular, microcrystalline quartz).

Most of the prices given in the article are a fair representation of current market prices and the stone's worth. However, azurite, lapis lazuli, malachite, tiger eye, and turquoise should not have the same value as agate! They are all comparable to opal in price and are purchased by the gram or carat, where agate is sold by the pound.

The research into the mystical properties was excellent; however, Mr. Lowrey should have

extended this to include materials on mineralogy such as "The Manual of Mineralogy" by J. D. Dana. After all, a good DM has to have accurate information and in some cases this requires research beyond the DMG.

Lori Adrian  
Chippewa Falls, Wis.

*I was going to run this letter without a response; I know better than to argue with an expert, and Lori's tangible criticisms seem valid and well expressed. It's the intangible criticism at the end of the letter that bothers me.*

*I don't know exactly how or where Mike got his "hard" information on the gems covered in the article; if he didn't look at any books specifically on the subject of mineralogy, then it appears he should have. But I know that his research did go well "beyond the DMG," especially in the scouring for information about the (alleged) mystical properties of the gems. If the criticism in Lori's last sentence implies something different, then I ought to point out that the roster of gems covered in the article did **not** go "beyond the DMG," because it was our intention from the start to only offer details about the gemstones that were given in the official AD&D® rules. — KM*

## Convention query

Dear Editor:

I always read the list of gamers' conventions in your magazine. Some of the entries say something about special rates for members. My question is, members of what? What organization do you have to belong to, if any? And how do you become a member?

Nathan Moon  
Ripon, Wis.

*In most cases, a "member" of a convention is someone who has registered to attend the event and has paid the admission fee ("membership fee") or donated money for the welfare of the sponsoring organization. The term is often found in listings for large gatherings, such as the World Science Fiction Convention, where you become a member by committing yourself to buying a ticket and planning to attend. In many cases, only members (those who have registered ahead of time) can attend a convention, and applications are cut off when a quota is reached.*

*Sometimes, a member is simply one of the people who belongs to the organization sponsoring the event — although it's hard to imagine this kind of member getting "special rates" when the idea is usually to attract as many non-members to a convention as possible. How much fun would it be for a gaming organization to sponsor a convention slanted toward its members — and what would be the point of announcing to the rest of the world that the convention was going to be held? To the best of our knowledge, we've never publicized a convention of this sort — because it's not a convention, it's a club meeting.*

*While we're on the subject, DRAGON® Magazine is interested in receiving notices of upcoming conventions from any sponsoring organization. Although we can usually tell when a notice is not entirely legitimate (and we've only received a couple of questionable ones in all these years), we cannot take responsibility for problems that arise if a convention does not come off as "advertised" in our calendar. But that doesn't happen too often, either; you can bet that if people go to the trouble of announcing their convention to thousands of people, they're also going to go to the trouble of holding it. — KM*



# In the VICTORY GAMES World of **JAMES BOND 007**

Role Playing In Her Majesty's Secret Service  
**THE EXCITEMENT IS JUST BEGINNING!**

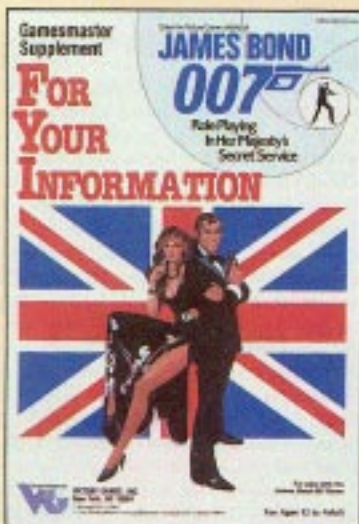

**New!**

**New!**

**Now Available!**

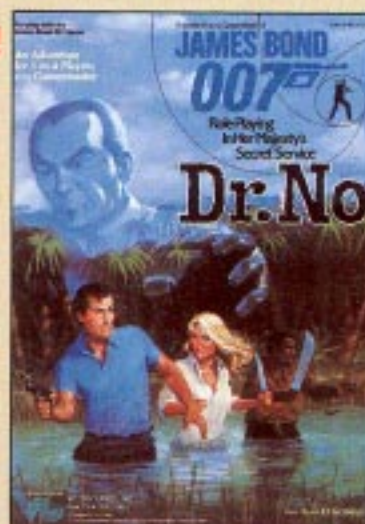

**FOR YOUR INFORMATION \$8.95**  
Gamesmaster Supplement

New rules and special features enhance the play of the *James Bond 007* game. Comps: 72-page Gamesmaster rules booklet, M.I.6 Dossier form pad, NPC card pad, Documentation form pad.

**DR. NO \$7.95**  
Adventure Module

Unravel the mystery of Dr. No, with characters and locations from the film. Comps: 48-page Gamesmaster Guide, M.I.6 Agent Dossier with 8 Mission Sheets, screen with maps.

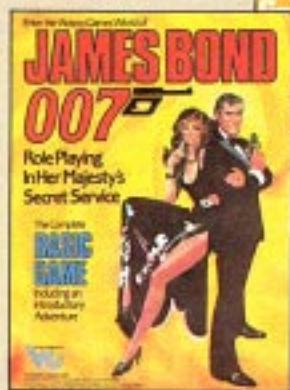

Coming this Summer...

**LIVE AND LET DIE**  
**YOU ONLY LIVE TWICE**

**Plus an All New Gamesmaster Supplement!**

**Sneak Preview!**

COMING SOON  
TO A STORE NEAR YOU!

From Russia With Love • Moonraker  
The Man with the Golden Gun  
Diamonds Are Forever • For Your Eyes Only  
The Spy Who Loved Me  
On Her Majesty's Secret Service



**VICTORY GAMES, INC.**

43 West 33rd Street New York, NY 10001

© Danjaq S.A. (1961)

© Eon Productions Limited/Gildrose Publications Limited (1984)





# The forum

## Opinions and observations

Edward R. Masters' contention that the official structuring of the elemental planes is nonsensical (Forum, #84) is well-taken; but then, by his reasoning, the entire AD&D® game universe is nonsensical. If we were to apply a little "serious reasoning" to the matter, we would be forced to admit that there is no way the AD&D cosmology could operate the way Gary Gygax has set it up.

First of all, the Prime Material Plane and all of its alternates are purported to be infinite, just like the real universe, but coexistent with the other planes. This is obviously an unworkable assumption. Any infinite plane would, by definition, displace or subsume all other planes. If the Prime Material was an infinite plane — or if we accepted one of Mr. Masters' infinite elemental planes — it would be the *only* plane. By this argument Mr. Masters' plan for the elemental planes is absurd.

Secondly, the entire notion of "plane" as used in the AD&D rules is erroneous. A plane is two-dimensional, yet the AD&D universe is obviously a three-dimensional place.

Third, the construction of the outer planes is laughable. Hell isn't particularly harrowing when one thinks of it as being nine contiguous boxes. But that's exactly what Hell is. The "ultra-cosmic impenetrable walls" that Mr. Masters found so insufferable between the elemental planes are the norm in the Outer Planes. The whole set-up looks like the Cosmic Balance's Filing System for Discarded Souls and Miscellaneous Beings ("A for Asmodeus . . . Let's see — oh, yes, ninth drawer . . .").

Finally, the system as a whole has one great big flaw: *Where is it?!* If all of existence is contained in the Inner and Outer Planes, then where or what is all the space that surrounds them? Look at the diagram on page 130 of the DEITIES & DEMIGODS™ book: It looks like two balloons floating around tied together by a string called the Astral Plane. Is all that white space supposed to represent "nonbeing"?

The point is that AD&D is a game, and to play that game we need a simple, understandable cosmology. The one in the game is at least consistent, if not rational. By eliminating or limiting the elemental planes, as Mr. Masters does, the DM is only limiting the scope of his or her campaign, and in more ways than simply losing those planes as setting for adventures. When you chuck the elemental planes, you kill lots of monsters: the elementals, djinn, efreet, xorn — these and more all disappear from the campaign. And if you discard the system for the elemental planes, how can you keep the Outer Planes in good conscience? I'm not saying that the game's system is perfect or that it should not be changed if the DM so desires (for example, all of the planes in my campaign are infinite, existing in separate but interactive continuums of reality), but the official one is the system the game is designed for and works best in.

Mike Beeman  
National City, Calif.

\* \* \* \*

In issue #84 there appeared in The Forum a letter asking why DRAGON didn't cover GEN CON more thoroughly than it does. Although DRAGON and GEN CON are both run by

TSR, the magazine maintains a separation from company policy and politics that is truly remarkable. The letter asked why TSR did not advertise and review GEN CON in the pages of DRAGON.

Well, if TSR were in financial hot water, it might make sense. But TSR is not, and DRAGON's hard-built reputation of being company-blind in reviews and ads is too valuable to risk by plugging for GEN CON. Endorsing one TSR "product" would lead to endorsing more, and that we don't need.

Not that I am against covering conventions. They are a valuable part of gaming, and I wouldn't mind seeing more than just their scheduled dates in DRAGON. But GEN CON is not the only good convention around: there's also the Game Faire, Aggiecon, Onocon, Orcon and GEN CON South, to name a few, which DRAGON would not do badly to review. Conventions deserve more mention than they have been getting, but without any loss of the impartiality which makes DRAGON so special.

Jennifer Walker  
Lake Oswego, Ore.

While reading Kevin Anderson's article "Wounds and Weeds" in issue #82, I couldn't help but think about combining the healing effects of several of the different plants.

Though the variation of climate and terrain in which the plants are found prevents characters from acquiring and using all of the plants at once, many of these plants could be sought out and the effects combined by the smart player character(s).

Here are some of the guidelines I follow in our campaign when allowing the characters to combine the effects of some of these plants.

First of all, plants like the Comfrey, where hit points "were never lost" because of the application of the plant, could be combined with the other plants like the Marsh-mallow or Aaron's Rod, where hit points are either gained permanently or fade within a short while, with hardly any chance of adverse conditions developing.

The system works like this: When combining two plants with almost the same method of healing, there is a 5% chance of an adverse result — paralysis for 1-2 rounds. When combining two plants with different healing properties, the chance of an adverse result is 10%, and that result is mild poisoning (save at +2 or lose 1-4 hit points). If three or more plants are combined, the chance of an adverse result increases by 5% for each additional plant. (It is suggested that the DM not allow more than six plants to be used together.)

If there are no adverse results found when combining certain plants, then those plants may be combined at any time thereafter with no chance of ill effects — but the opposite is also true: If an adverse result is found, then that combination of plants will produce an adverse result every time thereafter.

If healing plants are combined with a healing potion, I feel that the effects of both substances could be combined with no ill effect, though some DMs may decide differently.

Russell Thorp  
Tuleta, Tex.

In preparing to re-open my AD&D campaign I've been going through my meager collection of DRAGONS and have found nothing but controversy over one of the linchpins of AD&D role-playing: alignment. After all, a 25th level magic-user is just like every other 25th level magic-user, except for his/her outlook on life. Thus, alignment is the major method of defining a character's personality.

Normally, I would have kept this to myself and the players in my campaign, except for two of the letters in The Forum for issue #82: the ones from S.D. Anderson and Ralph Sizer. Both show a tendency rife within the AD&D "community" to read more into alignment than what is in the source material.

Basically speaking, alignment is a general definition of where an individual stands in reference to the two great struggles: Law vs. Chaos and Good vs. Evil.

First, look at Law vs. Chaos. I feel this is a poor choice of words, giving an undertone of good vs. evil and value judgment. (How many readers would rather live in a chaotic society than a lawful one?) Perhaps better titles would have been "Groupism" and "Individualism," for this is basically what the question boils down to. The lawful person believes that the "true path" lies in a strong central government, that the needs of the individual should be secondary to the needs of the group. The chaotic person believes in the right of the individual to determine his/her own destiny. A lawful person, then, will voluntarily submit to rules and regulations because this will make society as a whole stronger. The chaotic will submit to rules and regulations mainly to stay out of jail and retain his/her freedom of action.

Good vs. evil boils down to the value placed on human life. (This also extends to other races as well. It's up to the DM to determine which races, but the players have to be informed!) Those of good alignment value life highly and will not kill without good cause. Torture would not normally be condoned, depending on the needs of a greater struggle. Truth is revered, but can be stretched if circumstances dictate. The evil one, on the other hand, feels no remorse at killing, torture, or lying. Again, circumstances may dictate saving a victim or telling the truth.

Seen from this viewpoint alignment becomes quite clear. Although variations are apparent within each alignment, the lawful good character will have his/her viewpoint unique from that of a chaotic good.

Now on to the letter from S.D. Anderson, wherein the author cites the civilizations of Rome and Greece as lawful. Rome I accept without question, but Greece?! A civilization that fought numerous wars to avoid the ascendancy of one city over the other and form a central government? One that felt that each individual citizen should be in on all decisions of central authority? Granted, each city-state could be described as lawful, but the whole thing — never!

And as for Mr. Sizer's "Why there can never be an Anti-Paladin" letter, I find that one major point has been overlooked: choice. A person chooses his/her alignment. Thus it is no more difficult to be lawful good if one chooses to be than it is to be chaotic evil if that is your choice. And as for Mr. Sizer's penultimate sentence, chaotic evil gods would reward a character for "having fun" for the same reasons the lawful good gods reward their paladins — the character is furthering the ends of the god(s).

I do agree, somewhat, with the lack of chaotic paladins. A chaotic could not submit to all the rules and regulations required of a paladin and still be chaotic. A neutral could barely squeak  
(Turn to page 66)



Be all that you can dream . . .  
with

# HEROES

Avalon Hill's  
Role-Playing  
Magazine

If you can dream it, you can **be** it. That's what role-playing is all about. And now there's a magazine that caters to the needs of role-players. It's **HEROES**, Avalon Hill's new bi-monthly role-playing magazine. In the pages of **HEROES**, you won't find vague, generic articles on how to be a GM, reviews of last year's products or inaccurate gossip. What you will find are solid, playable adventures, new rules for the games you already own and colorful playing aids that add excitement to your campaigns. After all, playing the games . . . and dreaming the dreams . . . is what it's all about.

- ★ Material on such fine role-playing products as **JAMES BOND—The 007 ROLE-PLAYING GAME**, **POWERS & PERILS**, **RUNEQUEST** and **LORDS OF CREATION**.
- ★ Articles and columns by the best writers and designers of role-playing products, including **Greg Stafford**, **Tom Moldvay**, **Gerry Klug** and **Richard Snider**.
- ★ **A complete** 16-page adventure for one of your favorite role-playing games.
- ★ One or more full-color **playing aids**, including GM screens, character cards and cut-out cardboard figures.



Available  
NOW!

Credit card customers  
call **TOLL FREE**  
800-638-9292

One-year subscriptions to **HEROES** are available from:



**The Avalon Hill Game Company**

4517 Harford Road, Baltimore, MD 21214

**Subscription Rate**—\$12 for one year; \$18 for two-years  
Single Issues: \$3 (first issue Vol. 1, No. 1 still available in limited quantity)



# The ecology of the slithering tracker

by Ed Greenwood

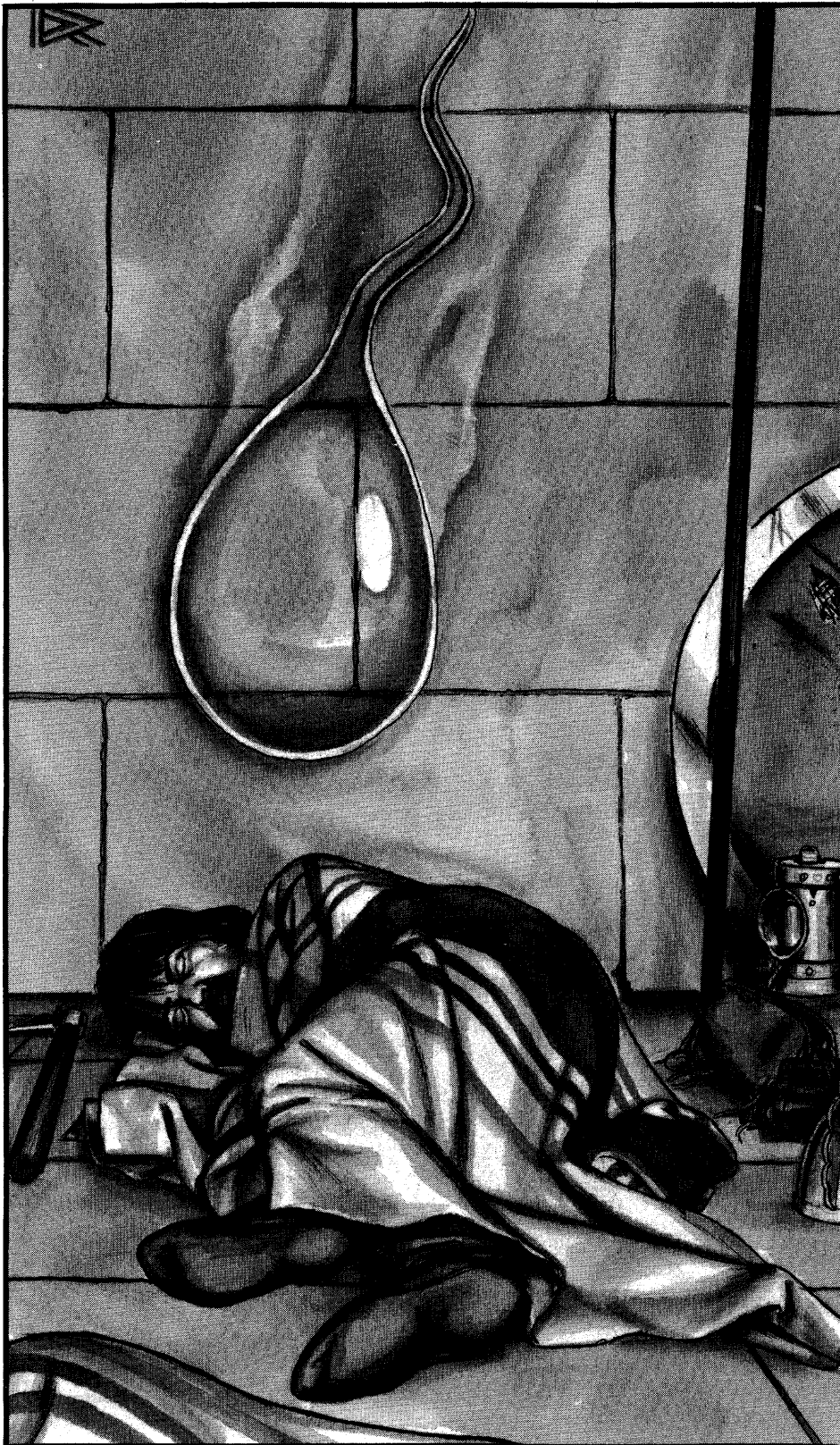

From the notes of the wizard Aluthandee:

It is called by such names as "The Invisible Death" or "The Creature That Follows The Doomed," and other fanciful phrases that suggest a thing of claws, fangs, and scaly limbs. When referred to by its mundane name, the Slithering Tracker is not nearly so imposing — and, indeed, it is not a vicious-looking creature, when it can be seen at all.

Close examination of the beast reveals it to be rather like a giant tadpole in appearance. Its transparent, semi-fluid jellylike body is customarily shaped into a blob with a long, sinuous tail. The body is amorphous, enabling it to pass through small gaps and holes, but it prefers to assume its tadpolelike form whenever possible.

Almost invisible and quite intelligent (especially for a slimelike creature), the tracker will lie in wait for prey in an advantageous location, such as in a cozy, apparently safe sleeping cavern, or at the bottom of a pit trap. It can grip and travel upon walls and ceilings and apparently can drop any reasonable distance without harm because of its form. When it moves, a tracker is almost silent except for the faint slither of its tail.<sup>1</sup> The creature exudes a very faint, sweet, "earthy" body smell, detectable only from inches away. The subtlety of its smell, sounds of movement, and appearance are such that it is virtually undetectable in the dimly lit subterranean areas it inhabits.<sup>2</sup>

A tracker feeds by first paralyzing an opponent with a fluid produced by its body cells, forcing this liquid into the victim through the pores of its skin, and then using a second fluid to actually erode the hide or skin of its victim, so that the creature can absorb the plasma from the victim's blood. Both the paralyzing substance and the fluid which effects the draining of the victim are produced automatically within the creature's body from any meal the creature consumes, the remainder of its fare being converted to energy for bodily activity, and sometimes being used to make itself stronger or larger. I know of no alchemists who can duplicate either of the tracker's fluids in the laboratory, but they eagerly make use of the former as an ingredient in the inks for the scribing of the paralyzation, *hold person*, and *slow* spells. Assassins, and alchemists in their employ, prize the skin-eating substance for use in the manufacture of caustic poison mixtures. These substances are present in each and every cell of the creature, and not collected in specific



areas or organs; however, they do readily settle and separate one from the other if a trapper's fluids are collected.

Trackers seem to prefer dwarves, humans, and giants as prey, in that order, over other creatures, presumably because of the physical make-up of their plasma.<sup>3</sup>

A tracker reproduces by budding. When specimens of full size gain further substance, they form excess body cells and place these in a pseudopod. All excess food (unless the parent creature is injured and reabsorbs these needed cells to maintain itself) is converted into more cells for this "bud." Such cells differentiate, and the pseudopod takes on the form of a second, miniature tracker joined to the first. When this is of sufficient size, the tracker produces brain-function cells for it, and these are passed into the "baby," which acquires limited sentience and begins to gain some control over its own form and actions. When it has mastered its form and gained strength, the parent tracker shakes free of it, and, after the initial shock of sudden, total self-control and loneliness, it will go its own way.<sup>4</sup>

Trackers are solitary, never merge with or fight other trackers, and inhabit a specific "territory" or range that they come to know very well, patrolling it regularly and recognizing instantly when some feature of it has changed. The tracker tolerates scavenger creatures who remove the bodies of its victims, but before abandoning a body it attempts to retain loose objects that might be recognized as treasure, so as to lure more prey in the future. A tracker lair is typically a tiny, irregular cavern too small for an attacker to effectively harm its occupant, located at the intersection of beckoning trails of treasure. A tracker can "burrow under" loose objects and carry them along for a distance before depositing them elsewhere, and in certain circumstances might lie dormant with treasure spread on top of itself.

A tracker's brain cells are located in various areas of its amorphous body; it has no special, vulnerable area. It can re-form if its bulk is separated in battle or misadventure, flowing together, or its various pieces attacking in combination, "like fingers of a closing hand," as the fighter Nerouth once put it. Such disembodied pieces will never voluntarily go off to seek their own territories; although they can survive permanently if of sufficient size, they will first seek to re-form once more into the full creature.

A tracker has apparently keen senses,<sup>5</sup> and once tracking intended prey by scent, will leave its territory and travel several miles, by dint of tenacity and perseverance in pursuit. It can think logically enough to deduce the probable destination of a target if the trail is wiped out by running water, heavy rain, or other means, but will not pursue if a large body of water intervenes, or if its quarry takes to the air.

Trackers seem to have a marked aversion to large bodies of water, but why this is so and precisely what effects water may have

on them are matters unknown to this chronicler. Some sages (Vaelenbras of Waterdeep, for one) believe that trackers instinctively fear strong currents and coastal tides and breakers, which may have the power to tear apart and forever scatter their jellylike bodies, while others (notably Jar-riven of Koss) assert that it is simple prudence: unlike those of the jellyfish, a tracker's fluid defenses may be weakened or dissipated entirely by water, and in such circumstances even small fish could readily devour it. (None of the adventurers I have spoken to will admit to success in neutralizing the creature's paralyzing fluids with water — but then, neither have I ever heard of a tracker being encountered, or attacking an adventurer, when the adventurer was immersed or swimming in water.)

A tracker will move into a heavily populated area if it can find a place for a good lair, where it believes it can remain undetected if it wants to. In pursuit of plentiful prey, it will leave its normal territory without hesitation — but will only do so in pursuit of men or larger creatures, and only out of starvation or desperation, not chasing off after every animal that happens past.

Whether these creatures can hear, and if so, understand speech, is a matter of great and continuing debate among local sages and naturalists. I suspect that they do hear, in a limited way, but no unquestioned proof has been set forth on either side of the debate. Much yet remains to be learned about this creature; my fragmentary researches have led my colleagues to give the creature yet another name — the "Aluthander," after me — and what little I have learned can be set forth on these few pages.

#### Notes

1. A slithering tracker forms a tail to aid it in rapid movement; the tail propels the creature along with a snakelike gripping and wriggling motion, at a rate of 12" per round. It will also form a tail — or two protrusions, at opposite ends of its body — with which to anchor itself by wrapping around objects, so that it can form a barrier across a hole or a trail to stop and entrap small animals. If it is not employing a tail, a trapper can only "creep" like an ochre jelly, at a rate of 3" per round. It will always form a tail and move faster than 3" per round when it is tracking prey; the tail will "disappear" when the creature attaches itself to a victim, or when the trapper is stationary for longer than one round.

2. Under outdoor conditions, not brilliantly sunlit, there is only a 5% chance of detecting a slithering tracker by normal visual means. This chance increases by 45% when the creature is on clear sand or stone of a solid color under bright sunlight. (Subtract 5% or 10% if the undersurface is mottled in hue or appearance, and further 5% increments as the light grows fainter or more diffused by overhead foliage, and for other conditions that inhibit full normal visibility.) A tracker is thus, at best, only detectable on a 50% chance — under

*optimum* conditions — to anyone not having a means of detecting or contacting an animal mentality, or the ability to detect invisible (in this case, transparent) objects or creatures. No tracker will voluntarily put itself in such optimum conditions — few will even venture outdoors at all, if they can help it — and the chance for detection is usually much lower than the optimum 50%. A trapper's body takes on the same temperature as its surroundings; as such, the creature is not detectable by infravision except during one of its attacks, or for a period of one turn (10 minutes) after it has drained plasma from a victim.

3. A tracker requires 6 uninterrupted turns to entirely drain a paralyzed victim. It will not attempt its plasma-drain attack against a conscious target who makes a saving throw vs. paralyzation and is thus still mobile; in fact, it will not attempt to make contact with conscious, mobile targets of halfling-size or larger unless it is starving

---

*A tracker will move into a heavily populated area if it can find a place for a good lair, where it believes it can remain undetected if it wants to.*

---

and desperate. If this happens, a mobile victim can easily and quickly (by pulling, scraping, burning, etc.) break a tracker's draining contact, leaving only a red, tender, non-bleeding area where contact with the tracker has resulted in the loss of skin layers. This reddened area is usually no larger than the circle described by an outstretched hand, and this is roughly the amount of exposed skin that must be available for the tracker to attach itself. The slithering tracker does not wrap itself around a victim, except possibly to curl its body around a patch of exposed skin on an arm, leg, or face; and it does not attach itself along the entire contacting surface of its body, even if a large area of exposed skin (such as a bare torso) is available. This is the main reason why it can be detached with relative ease.

A tracker will always attack sleeping or unconscious targets in preference to other sorts. A victim who is sleeping normally (not under a magical effect) will awaken on

the round when the tracker attaches itself, whether or not the victim saves vs. paralyzation. An unconscious victim will not revive as a result of the tracker's attack, unless the victim would have regained consciousness anyway at some point during the 6-turn time span of the plasma drain. A victim who suffers the plasma drain will lose one-sixth of its then-current total of hit points at the end of every full turn following the onset of the attack (round fractions up) — for 5 consecutive turns; assuming the plasma drain continues uninterrupted. At the end of the sixth turn, the victim loses all remaining hit points down to zero. The tracker will detach itself at this point, and if unaided the victim will continue to lose hit points at the rate of 1 per round thereafter until one more turn has passed, at which point the victim (assuming a character or other humanoid) is dead.

The creature can always tell whether or not its paralyzation attack has succeeded,

tracker if a target meets the creature more than one day after the initial encounter.

4. "Full size" in this context means a creature with 5 hit dice, or 23+ hit points. A "baby" of 2 hit dice, or 9+ hit points, is of sufficient size to acquire brain cells and limited sentience. The production of a pseudopod and specialized brain cells is instinctive when the creature is under the right conditions — but only a full-sized tracker of 5 HD can reproduce in this fashion. A parent instinctively parts from its pseudopod when the latter achieves 3 hit dice size, or 14+ hit points.

If a tracker is split into two or more smaller portions, its disembodied pieces will seek to re-form if possible, searching around in a small area (about 12" diameter) for their fellows. These disembodied pieces can survive if of 2 hit dice (9+ hit points) or more, but if less than 2 hit dice, they will die in 12-31 (d20 + 11) turns from lack of a sufficient number and balanced order of

die. When at rest, the body is in a flattened spherical shape; when in motion, it takes on a teardrop shape, bulkier at the leading edge. The tail which the tracker sends out to aid it in movement is in addition to its body length, tapering away from the direction of movement for a length of 4 or 5 feet in a full-grown specimen. The tracker cannot make abrupt changes of direction while in motion; to reverse its course, or even to make a 90-degree turn, it must come to a full stop for one round and then start off in the new direction. When one is trapped or cornered, it will make the best possible use of its natural defenses (transparency, body flexibility, and near-silent movement) to attempt an escape.

B. Even if a tracker is detected once, that doesn't mean the creature will remain visible indefinitely. It is easier to see when it is moving (add +10% to +20% to the base chance of detection, depending on lighting and terrain), but still may be able to slip away from an attacker. It is very difficult to keep track of a tracker long enough to kill it with normal weapon blows, since several different strikes over a span of several rounds would be needed. One effective tactic is to immobilize the creature with *hold monster* or similar means, then successfully detect it where it lies (if that is not already known) and smash away. Of course, the tracker's natural transparency can be easily offset by dousing it with dye or covering it with soot or dust; this will not suffocate the creature or inhibit its movement, but will certainly make it visible to anyone within sighting range.

C. Two events can cause a tracker to be split apart in battle; in either case, a hit from a slashing weapon (short sword or larger) is required. If an attack roll is one less than the minimum number needed to score a hit, the tracker takes no damage but is split into two creatures of identical size and hit points. Or, if a hit succeeds and does at least 6 points of damage, the creature is split into two equal-sized pieces, each with half of the remaining hit points (assign odd hit points to one half or the other). Example: A tracker of 5 hit dice, with 26 hit points, is cleaved in half by a blow from a longsword that does 8 points of damage. The result is two smaller creatures with 9 hit points each, now effectively 2 HD monsters (figuring  $4\frac{1}{2}$  hit points = 1 hit die).

Note that when a tracker is forming a pseudopod, the entire body of the creature may have more hit points (and, effectively, more hit dice) than would otherwise be normally possible. A 5 HD tracker with maximum hit points (40) could form a pseudopod and nurture that tracker-to-be, until the "baby" acquires 14 or more hit points, at which time it will separate from the parent. In the meantime, the reproducing tracker would be treated as a monster of as many as 7 hit dice, with a possible maximum of 53 hit points.

D. A tracker can gain new hit points (or regain lost ones) by draining plasma from a victim, at the rate of 1 hit point per turn of

---

***The tracker cannot make abrupt changes of direction while in motion; to reverse its course it must come to a full stop.***

---

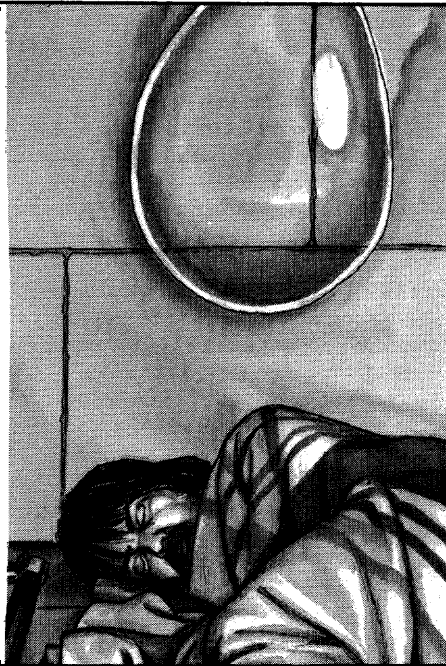

and it will not attempt to begin draining the plasma from an intended victim who makes his saving throw; instead, it will move away as rapidly as possible, trying to get out of range of a sleeping target before it awakens. The save vs. paralyzation — which any intended victim is entitled to — represents the chance that the intended victim has a temporary immunity to the tracker's fluids, because of the target body's present chemical balance, and because of the target's innate resistance to paralyzation attacks; this natural resistance is stronger for those of relatively high levels of experience or large numbers of hit dice. A target that has proven to be immune for the moment will not have to save again during the same engagement, and a tracker (unless desperate) is not foolish enough to attack the same victim twice in rapid succession. But if a target is attacked twice by different trackers, he must save twice to remain unaffected. A second save is required against the same

body cells. Such "doomed" fragments will be ravenously hungry, instinctively seeking sources of plasma, and will attack all likely targets encountered (conscious or not) without caution — for if they absorb enough plasma, they may be able to grow to a stable size and survive.

5. Trackers have no eyes as such, but possess an infravision sense that enables them to locate warm-blooded bodies in a 6" range. They are fairly keen receptors of odor, able to home in on body scents from 12" away with enough accuracy to discern the general direction they must take to keep on tracking their prey. They can sense even faint vibrations up to 16" away, even something as innocuous as the tapping of hard boots (but not soft ones) on a stone floor.

#### Appendix

A. The standard body size for a slithering tracker is 2½ feet, or (for smaller specimens) roughly ½ foot of length for every hit



draining. (The rest of the plasma is simply used to enable the creature to "eat its fill" and maintain normal bodily functions.) Depending on its size (number of hit dice), each tracker has a maximum number of hit points it can attain. This figure is determined by rolling a die or dice every time the tracker qualifies to grow into a larger hit-dice category. The creature can then absorb hit points from its plasma drain until it attains that maximum figure. If a tracker has taken damage, "plasma points" are first applied to bring the creature back up to its maximum number of hit points. When there is no damage to be offset, these points may be used (by a 5 HD creature) to begin or accelerate the formation of a pseudopod, feeding it until it acquires 14 hit points (3 x 4½, rounded up) and thereby qualifies as a 3 HD monster that can live on its own. Hit points that cannot be applied for one of these specific purposes are simply "wasted."

Example: A tracker pseudopod has just reached 14 hit points and separated from its parent. The DM rolls 3d8 to determine the maximum number of hit points this creature can attain as a 3 HD monster; if the result is 14 or less, then the tracker is already at its maximum strength and will never grow any larger. If the dice roll is 15, 16, or 17, then that is the creature's maximum hit-point figure, and it can never be more than a 3 HD monster. If the roll is in the range of 18 to 22, the creature is able to attain that many hit points and, upon doing

so, will qualify as a 4 HD monster. Upon reaching 18 or more hit points, the tracker is entitled to another d8 roll for additional hit points, and if the total of all the rolls is 23 or more, the creature will eventually be able to attain status as a full-sized 5 HD monster. Finally, when it gets to 23 hit points, it is entitled to one more d8 roll to determine the absolute maximum number of hit points it can attain. Note, again, that only a 5 HD tracker has the ability to form pseudopods and reproduce.

E. In general, the intensity of a tracker's appetite depends on how many hit points it currently lacks to fill its needs. A wounded creature, despite its condition, will be obsessed with bringing itself back to full strength — and trackers do *not* regain lost hit points by resting. As stated in note 4 above, tracker fragments of less than 2 HD will be ravenous, since they literally need food to have a chance of surviving. A tracker that is not wounded but has not yet attained its maximum potential strength (see the example in the preceding section) will hunger to do so, and will leave its territory in pursuit of prey. A creature currently at its maximum strength will not be eager to take chances, but won't turn away from a meal. In any event, a tracker must consume a full meal (one M-sized creature worth of plasma, or more) once per month, or it will lose hit points at the rate of 1 per day as its body begins to atrophy. And the more hit points it loses, the hungrier it gets. . . . □

## CAST YOUR OWN FANTASY FIGURES

### SPECIAL OFFER

For only \$9.95 (postpaid) you can get our \$15.95 fantasy starter set. It has everything you need to cast your own figures. Get in on the fun...

We now have 13 super fantasy molds with 39 great characters.



Casting your own figures is as much fun as playing the game.

Send \$1.00 for complete brochure (refundable).

**THE DUNKEN COMPANY**  
P.O. BOX 786D  
CALVERT, TX 77837  
CASTING IS EASY AND FUN

# DAREDEVILS™

## HAVE ADVENTURES!

You can too! **DAREDEVILS** is a game of role-playing action and intrigue set in the 1930's. Players design and develop their characters who may be investigative reporters, private investigators, globe-trotting soldiers-of-fortune, mysterious cloaked crimefighters, or any of the heroes fostered by the popular culture of the era. The Gamemaster incorporates these characters into fast-paced adventures full of master villains, mysteries, fog shrouded streets, furious gun battles, and cliff-hanger escapes.

So, come and join the adventures. Become a Daredevil!

**DAREDEVILS** comes as a boxed set that includes the rulebook, a referee's screen with useful charts and a political map of the world, and **DAREDEVIL ADVENTURES**. This last is a collection of four adventures which allows you to begin play with a minimum of preparation.

The boxed set is available for only \$15.00.

#### ALSO AVAILABLE:

- **Daredevil Adventures 1: featuring Deadly Coins**
- **Daredevil Adventures 2 with Menace Beneath the Sea**
- **Daredevil Adventures 3: Supernatural Thrillers**

Each adventure is \$5.00



# Lands of Adventure™

A new and exciting Fantasy Role Playing Game with add-on culture packs to adapt the basic rules to various cultures from both history and myth. The basic rules cover everything from character creation and advancement to combat, skills, and magic. Cultures are fully explained for detailed and believable worlds.

The basic game comes as a boxed set including the basic rules, character sheet, and a double culture pack describing the worlds of Medieval England and Mythic Greece.

Each Culture pack also includes scenario and adventure outlines.

**Lands of Adventure** is a complete adventure role playing game for only \$12.00.

Available from local shops or direct from us: P.O. Box 182, Roslyn, N.Y. 11576

Please add \$2 for postage



New York residents, please add sales tax.



# Familiars with a special use

New 'pets' that match the magic-users who call them

by Stephen Inniss

Vlademok, a chaotic neutral magic-user, tries to summon a familiar. "Be nice to have a toad," he muses, "with plenty of warts." But the die roll grants him something special: a minor demon form called the quasit. Now, unlike poor Vlad, the quasit is an evil creature. While Vlademok's dismal new life continues, the quasit counts the days until his master's death — because then it can fulfill its evil mission and deliver Vlad's soul to the Abyss. "Revenge will be sweet," thinks the quasit, who resents his servitude to Vlad. "All I wanted was a toad," whimpers Vlademok, who wonders how he earned such a fate. . . .

In the AD&D® game, magic-users have roughly a 576 chance of summoning a special familiar — a brownie, imp, pseudo-dragon, or quasit — with the first-level spell *find familiar*. Unfortunately, this feature suffers from a lack of completeness, resulting in an unbalanced (if not unfair) game. The alignment of a special familiar does not always match the alignment of its master. The creatures differ in origin and strength, and evil magic-users seem favored with the most powerful familiars. True, the evil M-U stands to lose more if his familiar is destroyed, but his animal's superior hit points and special powers (especially regeneration) give it a much stronger grip on life, compared to its good-aligned cousins.

The least disruptive solution to these imbalances is to divide the familiars into two groups, natural and supernatural, and add new creatures to fill in the gaps. In this way, regardless of alignment, a magic-user may summon either type of creature. (In the current system, only good guys get the naturals and evils the supernaturals.) And regardless of the creature's origin, the familiar will always be a good match for its master's alignment. Thus, magic-users who are neither good nor evil will find more agreeable familiars, and good magic-users will find creatures who can champion their cause against the evil imps and quasits. The result: more balance, and a few interesting new creatures.

## Supernatural familiars

The extraplanar special familiar differs completely from its cousins of the material plane. It is actually a lesser devil, demon, deva, or other such being from the outer planes. A magic-user who summons such a familiar enters into a pact far more grave and important than one who accepts

another sort of animal. When he summons a supernatural familiar, the spellcaster has actually captured the notice of his deity, or at any rate, a deity with the same alignment. This deity sends one of its least minions to guard and guide its summoner, to see that the magic-user champions the cause of the appropriate alignment. Beyond these worldly duties, the familiar may actually bring or guide the spellcaster's spirit to the appropriate plane after death. In return, the magic-user gains much power on the material plane during his life, and he gains a useful servant and companion. Evil magic-users are best known for making pacts with supernatural familiars, but this is mainly because ill repute spreads faster than other kinds of fame.

The magic-user and his supernatural familiar have a complex relationship. Although the familiar has come to serve, it also has come to give advice, either directly or through contact with its plane of origin. They may be among the least of beings on their respective planes, but the supernatural familiars are of purer and more unswerving alignment than most residents of the material plane. In this sense, they are superior to their masters. All supernatural familiars are fully aware that in the end they must bring their master to his final home; no matter how the familiar feels about this, he'll never forget it.

Thus, in some ways, the supernatural familiars are more like henchmen than servants, if they don't become full associates. On occasion, they may refuse orders; in fact, the familiar may attempt to give them, particularly in matters concerning alignment. Supernatural familiars use whatever methods they can to keep their masters on the right path, including subtle (or perhaps not so subtle) persuasion.

If the magic-user changes alignment, the familiar has the option of leaving. The master's unwillingness to reform is equivalent to sending the familiar away. Whenever this happens, the results are as described on page 44 of the *Dungeon Masters Guide*.

Supernatural familiars fight when they have to, but they probably won't risk their lives to do it. They observe their duty to provide aid and advice, but they won't fill in as general bodyguards. Supernatural familiars are 90% unlikely to risk their lives for their masters (as stipulated in the spell description for imps and quasits) — and it is rare that their masters would want them to, considering the penalties the master would have to pay in such an event. A good

familiar who watches its master approach destruction often consoles itself with the thought that at least its master will go to a deserved reward, beyond the reach of the material plane's temptations. A neutral familiar tends to feel the same way, and doesn't forget that it may gain something if it brings another soul to its home plane. An evil familiar, of course, cares nothing about the welfare of its master. But it stands a good chance of being promoted if it brings its master to the proper lower plane. Furthermore, it enjoys the thought of this temporary superior undergoing torment on that plane.

A magic-user who has died and been taken to the appropriate plane might be difficult to raise or resurrect. A god or demigod that has gone to so much trouble to secure a soul may not wish to risk losing it again to the unpredictable material plane. The being may have some reason for wanting the magic-user to stay on the material plane, but it will not take such a risk if the spellcaster shows signs of wavering in alignment. Evil powers are particularly reluctant to relinquish a soul, since the magic-user has seen what lies in store for him, and may repent once he returns to the material plane.

If by chance a cleric receives a supernatural familiar, the comments above still apply. However, the cleric's deity rarely grants such companionship; after all, the deity already has the cleric's devotion, and he already spends a great deal of effort on the cleric's behalf by sending spells.

Supernatural familiars have a number of common characteristics, and they bestow similar powers upon their masters. Perhaps these characteristics come from some unspoken agreement among the powers of the outer planes, or perhaps the different familiars have similar origins. Whatever the case, they do share several traits:

### All supernatural familiars

FREQUENCY: *Very rare*  
NO. APPEARING: 1  
ARMOR CLASS: 2  
% IN LAIR: *Nil*  
TREASURE TYPE: *Q(x3) or X*  
MAGIC RESISTANCE: 25%  
SIZE: S  
PSIONIC ABILITY: *Nil*

Certain of these statistics apply only on the material plane. The creatures that serve as familiars may be found with greater frequency and in greater numbers else-



where. Likewise, on the home plane they may have a "lair."

While on the material plane, a supernatural familiar may acquire treasure, either when serving as a familiar or when on some other mission. Motives for gathering treasure vary widely among familiars, but when treasure is taken, it is portable and useful. This applies to magical treasure as well (though supernatural familiars have only a 25% chance of having type X treasure). The magical treasure could be something saleable, but it could also be a wand, for instance. Supernatural familiars can employ any wands usable by all character classes: wands of *enemy detection*, *illumination*, *magic detection*, *metal & mineral detection*, *magic missiles*, *negation*, *secret door & trap location*, and a *wand of wonder*.

None of the supernatural familiars exceed 2¼ feet in height, but it is still difficult to harm them. All supernatural familiars can regenerate 1 hit point per round, so only the total destruction of their tissues can kill them. Given time, they can even replace lost organs, as well as entire limbs. They are immune to both cold and electricity, and have varying degrees of immunity to other forces. Ordinary weapons are worthless against these familiars, though magical (+1 or better) weapons harm them, and special weapons may also be effective. In addition to their magic resistance, supernatural familiars save vs. all spell attacks as 7 hit dice creatures. Of course, an opponent

must locate the familiar before he can try to harm it; these animals can all become *invisible* at will.

Supernatural familiars have several offensive powers to complement the defenses listed above. They can perform some spell-like actions at the 7th level of proficiency, including *detect magic* (as a magic-user) and *detect evil/good* (depending on alignment; as a cleric) — both at will. These familiars can also *polymorph* themselves into a limited number of shapes. When one assumes a new shape, it has the senses, movement rate, attack forms, and armor class of the creature whose shape it has taken. However, the familiar retains its normal number of hit dice and hit points, as well as all magical abilities and immunities. In some cases, the familiar must choose its alternate shape from a limited selection when it arrives on the material plane. Once it has made this choice, it can assume no other shapes unless the powers of its home plane intervene. The familiar retains the same appearance for any given shape; if one becomes a little brown dog, then that's the only dog-shape it can ever assume.

In polymorphed form, a familiar can speak only if the animal it mimics can do so (e.g., a raven). In their unaltered form, all supernatural familiars can speak. Each knows its alignment language and the common tongue, as well as any other languages it may have learned during its life on the material plane.

## DIAMOND DICE, Inc.



Over 300,000  
Sold

Specializing in inked dice, dice sets, jumbo dice, frosted dice, dice pouches, & more . . .

### MASTER DICE SETS

(6 different dice)

94	Black Dice/Silver Ink	\$6.60
108	Diamond Dice/Blue Ink	\$7.50
112	Transparent Blue Dice/Silver Ink	\$7.50
115	Transparent Purple Dice/Silver Ink	\$7.50
1010	Jumbo Inked 4 Dice/4 Colors	\$6.00
8001	Diamond Dice Uninked	\$4.50
8016	Frosted Transparent Dice/Inked 6 Different Colors	\$7.50

Available at Better Hobby and  
Game Stores or Order Direct

Send for your dice set list or  
send \$1.00 for catalog

Please specify number when ordering

Add \$1.00 postage and handling per order  
\$2.00 overseas

Ill. Residents add 6% Sales Tax

**Diamond Dice, Inc.**  
324 So. Fairview  
Park Ridge, IL 60068

(312) 692-7165 or (312) 392-7725

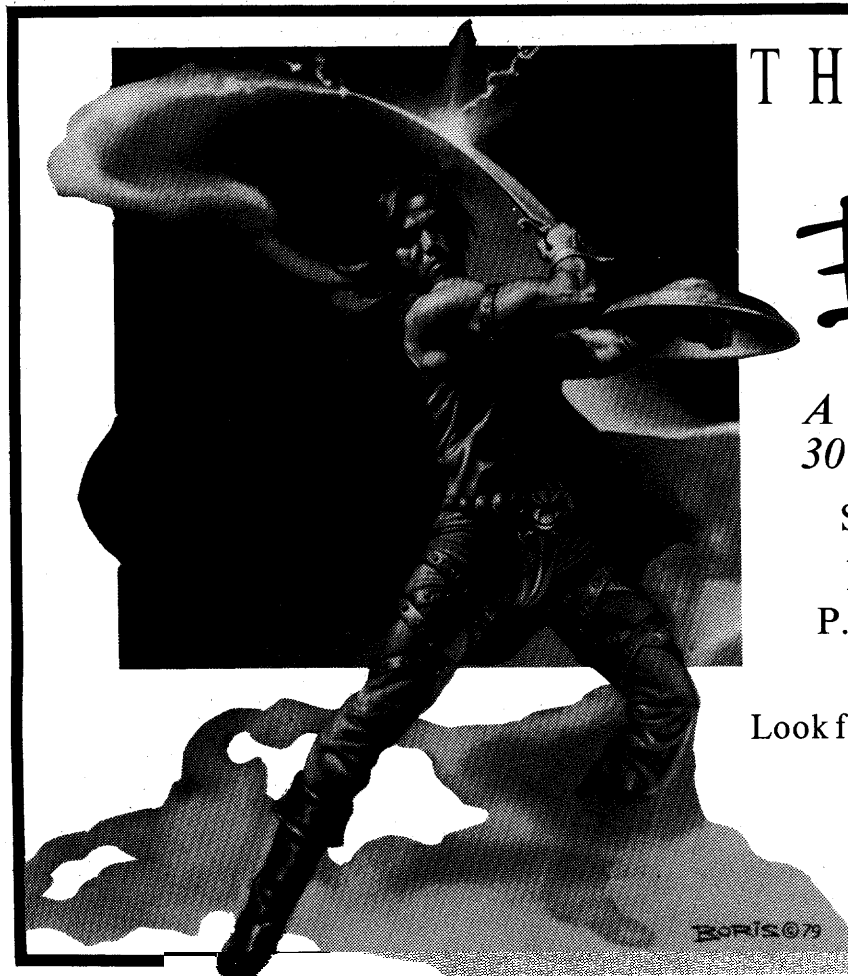

# THE WORLDS OF

# BORIS VALLEJO

*A boardgame illustrated with  
30 different Vallejo paintings.*

Send \$17.00 plus \$1.00 S/H to:

**MAYFAIR GAMES INC.**

P.O. Box 5987 Chicago, IL 60680

At fine Hobby stores

Look for other fine Mayfair Games including:

**Company War**

**Dragonriders of Pern**

**The Keep**

**Sanctuary**



As "aliens" of a sort, supernatural familiars are vulnerable to otherwise harmless products of the material plane. Evil ones are harmed by holy water, good ones by unholy water. A cleric of 8th level or higher can turn away a supernatural familiar, using the "special" line on the "Matrix for Clerics Affecting Undead, et al." (DMG, p. 75) — and note that this applies to good familiars as well as evil ones. Magical diagrams can trap supernatural familiars within certain areas or exclude them from others. Certain spells affect them, particularly those designed to harm or drive away extraplanar creatures. A *holy word* spell or its reverse can drive them off the material plane completely. (Note: familiars of neither good nor evil alignment aren't affected by the spell as written.) Fortunately, they each have a personal name that the hostile spellcaster may have to know to make his spell work.

A familiar's extraplanar nature is of course not a complete liability on the material plane. A supernatural familiar is useful for negating the effect of *ahold portal* spell. The familiar can attack and damage creatures that normally withstand all but magical weapons, provided that the familiar attacks with its body, whether in natural or polymorphed form. (The familiar cannot harm such creatures by wielding a non-magical weapon.) And, supernatural familiars do not age, so they are immune to a number of unpleasant effects associated with that phenomenon.

A supernatural familiar offers a number of benefits to its master. Once a week, it can contact its plane of origin for advice; treat this as a *commune* spell allowing six questions. Under the right conditions (which aren't difficult to achieve), a supernatural familiar endows its master with the same 25% magic resistance it possesses, plus an additional level of experience and the ability to *regenerate* 1 lost hit point per round. A supernatural familiar can convey all it senses to its master via a telepathic link, and this link also serves as a conduit for the special powers. However, the link grows weaker with distance; if master and familiar are more than 1" distant from each other, the familiar cannot bestow magic resistance or regenerative abilities; if the two are more than 1 mile apart, the familiar cannot send sensory information, and the spellcaster loses the level he had previously gained.

If a supernatural familiar is killed, its master loses four levels from his current level, as if he were drained by an undead creature. This may mean the death of the master, but if he survives the level loss, then perhaps he can bring back the familiar with a *wish* spell. Otherwise, the familiar is forever lost to its master, even if it is not utterly destroyed but merely returned to its home plane. If the master does not survive the level loss but is later *resurrected* and/or *restored* back to health, he can ultimately obtain a different familiar (perhaps even another one of the same type, die roll permitting), but cannot regain the original familiar, even by means of a *wish*.

All potential familiars are allowed a saving throw to escape the effects of the *find familiar* spell. Special creatures are even more likely to avoid the spell, because all of the supernatural familiars and most of the natural familiars (see the section following this one) have innate magic resistance that must be overcome before the saving-throw roll can even be attempted.

The potential supernatural familiar is especially resistant to being summoned by the *find familiar* spell because it may not want to take up hazardous duty on the material plane, no matter how greedy, dutiful, kindly, or ambitious it may be. These lesser representatives of their planes may well be more steadfast in their alignments than the masters they would serve, but at the same time they are less steadfast than their superiors from their home plane might be; they are relatively less devoted to their cause and more vulnerable to fears and uncertainties. Most of all, potential supernatural familiars will fear that the summoner is only weakly aligned and might even change alignment at some later date. The supernatural familiars tend to prefer older and more powerful masters, confirmed in alignment and more likely to accomplish great things for which their familiars may take some credit. Since the power of the spellcaster's magic is reflected in its ability to offset the creature's magic resistance, this resistance (over and above the saving-throw odds) serves to help the

potential supernatural familiar screen out the summons of some hopeful prestidigitator destined for a short or (even worse) mediocre life.

In terms of game mechanics: Even if a chaotic evil 1st-level magic-user makes the necessary roll to qualify for a special familiar, his chance of getting a quasit to heed the call is less than 14% (considering the creature's magic resistance followed by a saving throw, if its magic resistance (75% vs. a 1st-level caster) happens to fail. Even if an 11th-level caster is involved, the chance of getting a quasit to come when it's called is still only about 40% — again, not counting the slim chance of rolling a 15 during the casting of the spell. Clearly, a special familiar will be readily inclined to "allow itself" to be pressed into service only if the summoning caster is of exceptionally high level.

The supernatural familiar's plane of origin corresponds exactly to the magic-user's alignment. The new supernatural familiars described below come in three classifications depending on their degree of good or evil, although law and chaos are just as important to them. The galadur come from the upper planes, the lomendur from the middle planes, and the burzugdur from the lower planes. Within each of these groups, the lawful, neutral, and chaotic members share certain characteristics. They are first described collectively, then as individual creatures.

## THE GALADUR

No one knows the origin of these lesser minions of good. Perhaps their origin is analogous to that of their evil counterparts, or perhaps they are a lesser race of deva. Although they may come to the material plane for other reasons, they usually appear as familiars to magic-users or clerics of good alignment.

All galadur have the usual supernatural powers, but they also possess a number of distinctive powers. For instance, galadur can surround themselves with a silvery light. This light is as bright as that shed by a magical dagger, illuminating a 10' radius. The light does not interfere with infravision or ultravision. Once per day, the galadur can create a single blaze of light, though a galadur who does this will be unable to produce any more light at all for one day thereafter. The effect of this blaze equals that of the *sunburst* power from a *wand of illumination*. This yellow-white blaze of light shines in a 2" radius around the creature. Those who are inside the area of the burst or standing within 12" of the galadur while facing it must save vs. spell or be blinded for 1 round. Undead caught inside the 2" radius of the blazing light will suffer 2-12 points of damage (save vs. spell for half damage) but are otherwise unaffected, even if they are looking at the light from a distance. A *continual darkness* spell will negate a galadur's ability to produce light for one

### Feudal Lords



**The original medieval pbm game of economic development, military conquest, and political intrigue.**

**Feudal Lords** is a computer-moderated play-by-mail strategic game of power politics set in Arthurian England.

Each player is the lord of a medieval fiefdom seeking to become King against up to 14 other players and over 30 non-player lords controlled by the computer. To accomplish this task, a player may select from over 30 types of military, economic, and diplomatic orders each turn.

- The game is processed entirely by computer for fast, accurate, and impartial results.
- A two-page computer printout details each turn's economic results and reports all major battles fought.
- Armies may move by land or sea, limited only by the extent of their lord's political influence.
- Other features include random events, spies, vassals, trading, mercenaries, and more.
- Rated one of the four best pbm games as reviewed in issue #72 of *DRAGON* magazine!

**GRAAF SIMULATIONS**  
27530 Harper  
St. Clair Shores, MI 48081

ENTRY: \$10.00 for the rulebook, set-up, and first 3 turns;  
\$2.50 per turn.  
RULEBOOK only: \$2.50



GAMES WORKSHOP presents

# CITADEL MINIATURES



PAINTING BY  
RICK OLSEN

THE GIANT PICTURED HERE IS SHOWN ACTUAL SIZE. THE SET INCLUDES FIVE DIFFERENT HEADS, A SELECTION OF WEAPONS, AND VARIOUS 25mm VICTIMS.



## CITADEL BOXED SETS

### SPECIALTY SETS

- 8031 WARRIORS OF CHAOS
- 8032 DWARF KING'S COURT
- 8033 KNIGHTS OF CHAOS
- 8034 GOBLIN RAIDING PARTY
- 8035 KNIGHTS OF LAW
- 8036 WHITE DWARF PERSONALITIES

### CITADEL PRESENTS

- 8023 HEROIC ADVENTURERS
- 8024 CHAOS MARAUDERS
- 8025 ORC WAR MACHINE

### STARTER SETS

- 8010 DUNGEON ADVENTURERS
- 8011 DUNGEON MONSTERS

## GAMES WORKSHOP (U.S.)

9110 F Red Branch Rd.  
Columbia, MD 21045  
(301) 964-0262



ALL BOXED SETS ARE \$10.00 WITH  
THE EXCEPTION OF 8025 WHICH IS \$16.00.

STOCK NO. 8042 \$135.00

day thereafter. A darkness spell negates the ability for the duration of the spell. In either case, the spell must be cast directly upon the familiar. A galadur cannot be blinded or dazzled by strong light of any kind.

Each galadur is especially resistant (treat as 50% magic resistance instead of the usual 25%) to one particular type of magic: either fear, illusion, or control. Once per day, a galadur may attempt to extend some of this protection to all within 3", calling out in a clear voice that has an effect similar to the cleric spell *remove fear*. As long as the galadur resists the spell, or has already done so, recipients of this protection will save at +4 vs. the type of spell in question for the next turn, or if they have already succumbed, are allowed a second saving throw (but with no bonus). A galadur can also *create food and water* once per day, and can *detect evil* or use *ultravision* at will (in addition to keen normal vision).

Galadur have several special immunities besides those they share with other supernatural familiars. They do not take damage from normal fire or non-magical weapons, and magical fire or dragon-breath fire inflicts only half damage at best (save for no damage).

Every galadur has a dexterity of 16, which is taken into account for missile combat and certain saving throws. (This does not further alter the galadur's armor class, however; it remains at 2, the figure for all supernatural familiars.) Galadur

have a charisma of 16 in dealings with other creatures.

Galadur may use small weapons such as those employed by pixies and sprites. A galadur's longsword strikes like a dagger, and the creature wields it with enough speed and skill to strike twice per round. A galadur's bow has half the range of a longbow, and its arrows do the damage of darts. Because of their dexterity, they have a +1 to hit with their bows. Galadur who have dwelt on the material plane for some time may have silver, cold-iron, or even magical weapons, but in general, the creatures are rarely this well equipped. When they first arrive on the material plane, they carry no arms.

#### Telperan

MOVE: 12"/30"/15" (MC:B)  
HIT DICE: 2+3  
NO. OF ATTACKS: 2  
DAMAGE/ATTACK: *By weapon type*  
INTELLIGENCE: *Very*  
ALIGNMENT: *Lawful good*  
SIZE: *S (2¼' tall)*  
LEVEL/X.P. VALUE: *V / 305 + 3/hp*

Telperi hail from the planes of Arcadia and the Seven Heavens. Each one may take the form of a small human or demi-human child, looking about seven years old. It may also appear as a large hawk, a mouse, or a dog (treat the latter as a wild dog). In addition to the abilities common to all galadur,

telperi have the power to cast a *magic missile* spell once per day. They have special resistance against any spell that causes fear or despair, such as *cause fear* or a *symbol of hopelessness*.

Telperi maintain an attitude much like a paladin's, though telperi from Arcadia place law above goodness in importance. They are the most martial of the three types of galadur. While they obey their masters in most cases, by nature they cannot knowingly perform an evil or unlawful act.

In their normal state, telperi look like small but extremely handsome or beautiful humans, with golden-brown to golden-pink skin, golden hair, and glowing amber eyes. They have pure white hawklike wings.

#### Glissan

MOVE: 15"/24"/18" (MC:A)  
HIT DICE: 2+1  
NO. OF ATTACKS: 2  
DAMAGE/ATTACK: *By weapon type*  
INTELLIGENCE: *Very*  
ALIGNMENT: *Neutral good*  
SIZE: *S (2¼' tall)*  
LEVEL/X.P. VALUE: *V / 305 + 3/hp*

The glissi come from the planes of the Twin Paradises, Elysium, and the Happy Hunting Grounds. Their superiors nearly always send them to the material plane to be familiars; only rarely do they come to do anything else. Like a telperan, a glissan can polymorph itself into the shape of a human

BODY WOUND 53



SCORE  
2

Tell opponent: "Do only Green or Yellow next turn."

# We've taken the dice out of fighting...

Any two books from Nova's new picturebook game, *Lost Worlds™*, allows players to recreate exciting swordplay between mythical heroes and monsters. Utilizing a system similar to the award-winning *Ace of Aces®* WWI dogfight game, *Lost Worlds* incorporates true hidden movement through an ingenious coding system. You call "24—Downswing Smash." Then your opponent calls "2—Sideswing Low" . . . You score a deadly body wound! Agility and armor are already figured in—all without dice and confusing charts and tables. Only your skill counts and you can see the results!

The rules, including multi-player combat and character improvement, are so concise that they take up only two pages. All *Lost Worlds™* game characters are based on Ral Parthá miniatures and include a coupon good for 10% off the depicted figure. Each character is different in its strengths, weaknesses, and maneuvers and is compatible with any role-playing game on the market today.

Now available at \$5.95 per book are: Man with Sword and Shield; Skeleton with Scimitar and Shield; Dwarf with Two-Handed Axe; Goblin with Mace and Shield (shown); Woman with Sword and Shield; Hill Troll with Club; Wraith with Sickle; Barbarian with Two-Handed Sword; and, Fighter-Mage with Magic Sword.

New characters appear monthly, so collect the whole set. Look for them in your local hobby store or write for our current catalog, c/o Dept. D.

**Designed by Alfred Leonardi, designer of Ace of Aces.®**

50—53	54—45	58—35	62—35
52—33	56—17	60—11	64— 3

54



## Game Designs, Inc.

P.O. Box 1178,  
Manchester,  
Conn., 06040



# SPACE OPERA™

SPACE OPERA OPENS A GALAXY OF DETAILED ROLE PLAYING. THE TWO 90+ PAGE BOOKS COVER A VARIETY OF TOPICS INCLUDING CAREERS, EMPLOYMENT, RESEARCH, PSIONICS, EQUIPMENT AND WEAPONS, STARSHIPS, COMBAT, TRADE AND COMMERCE, ALIENS, WORLD CREATION, BEASTS, AND DETAILED PLANETARY SOCIETIES. FIVE SAMPLE STARSHIPS, WITH DECKPLANS, ARE INCLUDED. THE RULEBOOKS WITH HANDY REFERENCE SHEETS (BOXED) ARE READY TO BLAST YOU ON YOUR WAY TO GALACTIC ADVENTURE FOR \$20.00.

## ALSO AVAILABLE:

**GROUND & AIR EQUIPMENT:** A detailed listing of heavy military equipment including tanks and StarFighters for the major starfaring races. \$6.00

**SELDON'S COMPENDIUM OF STARCRAFT 1:** A collection of more than 20 starships of assorted sizes. The emphasis is on commercial craft and full statistics and deckplans are provided for each ship. Details on standard shipboard compartments and facilities are also provided to make a very handy reference for any campaign of SPACE OPERA. \$6.00

**SPACE MARINES:** Tactical miniatures rules in the SPACE OPERA universe with organizations & uniforms. \$7.50

## STAR ATLASES

**STARSECTOR ATLAS 1** (The Terran Sector) \$7 • **STARSECTOR ATLAS 2** (The Mercantile League) \$7.00 • **STARSECTOR ATLAS 11** (The CSA) \$6.00 • **STARSECTOR ATLAS 12** (The Korolian Empire) \$6.00

## ADVENTURES

**MARTIGAN BELT** \$5.00 • **PROBE NCG 8436** \$5.00 • **VAULT OF THE N'ER QUEYON** \$5.00 • **FASOLT IN PERIL** \$4.00 • **AGENTS OF REBELLION** \$5.50 • **INCEDUS III** \$5.00 • **ROWSION II** \$5.00 • **OPERATION PEREGRINE** \$6.00



THE COMPLETE SCIENCE FICTION ROLEPLAYING SYSTEM



© 1981

P.O. Box 182,

ROSLYN, NY 11576

# BUSHIDO™

Flashing bladework, brave warriors, martial mastery, wise priests, honor, stealthy assassins, demons, magicians, spirits, war — the stuff of Legends, the Legends of Japan. BUSHIDO is a role playing game that allows you to adventure on the Misty Isles of Nippon.

Players in BUSHIDO design their characters to suit the profession they choose. A skill system is used to determine the character's success in both martial and peaceful endeavors.

Take a break from the Western European and sample the mysterious world of the Far East. Try adventuring in a world where a man's honor and fame are as important as the number of foemen he has slain.

Come follow the code of the Samurai, the Way of the Warrior. BUSHIDO!

BUSHIDO is available for \$18.00. Also available is THE VALLEY OF THE MISTS, a BUSHIDO adventure pack for \$5.00.

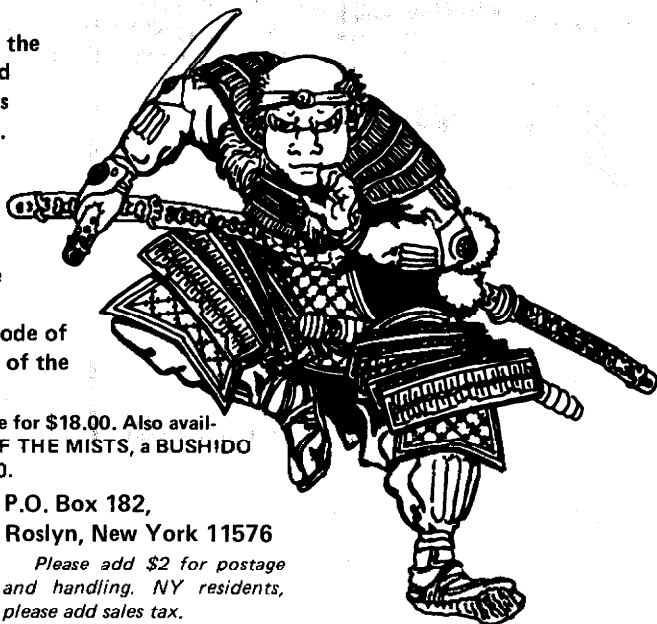

P.O. Box 182,  
Roslyn, New York 11576

Please add \$2 for postage and handling. NY residents, please add sales tax.

# VILLAINS AND VIGILANTES™

A SUPER-HERO ROLE PLAYING GAME

You can combat the forces of evil! You can become a champion of truth and an idol of millions! You can be a superhero and defend the human race against injustice and villainy! You can do all this as your character in the game VILLAINS AND VIGILANTES.

The rules deal with Superpowers, Secret Identities, Combat, Encounters, Character Creation and more! VILLAINS AND VIGILANTES comes as a boxed set with the rulebook, introductory adventure, character sheet, reference screen and dice for only \$12.00.

Rulebook alone . . . . . \$6.00  
Introductory Adventure (Crisis at Crusader Citadel) . . . . . \$5.00

## Additional Adventures:

Death Duel with the Destroyers \$5.00  
The Island of Dr. Apocalypse . \$5.00  
F.O.R.C.E. . . . . \$5.00  
Opponents Unlimited. . . . . \$5.00  
Most Wanted (Vol. 1). . . . . \$5.00  
The Dawn of DNA . . . . . \$5.00

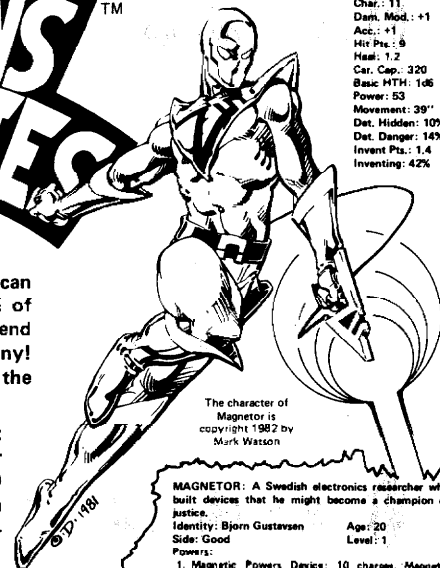

Wt.: 180 lbs.  
Str.: 14  
End.: 13  
Agil.: 12  
Int.: 14  
Chr.: 11  
Dark. Mod.: +1  
Acc.: +1  
Hit Pts.: 9  
Heal.: 1.2  
Car. Cap.: 320  
Basic MTH: 1d6  
Power: 53  
Movement: 39'  
Det. Hidden: 10%  
Det. Danger: 14%  
Invent Pts.: 1.4  
Inventing: 42%

The character of Magnetor is copyright 1982 by Mark Watson

**MAGNETOR:** A Swedish electronics researcher who built devices that he might become a champion of justice.  
Identity: Bjorn Gustavsen Age: 20  
Side: Good Level: 1  
Powers:  
1. Magnetic Powers Device: 10 charges. Magnetic capacity = 4200. Magnetic blast range = 21'  
Magnetic control, once achieved, lasts 12 turns.  
2. Life Support Device: 30 charges; PR = 1 per hour.  
3. Heightened Senses Device: Nightvision goggles, full detection scores in darkness.

FANTASY GAMES UNLIMITED  
P.O. Box 182  
Roslyn, New York 11576

Please add \$2 for postage and handling. N.Y. residents, please add sales tax.

or demi-human child about seven years old. The glissan can also assume the shape of a songbird, a seagull, or a miniature unicorn (2' high at the shoulder). As a unicorn it becomes AC 4, runs at 24", and strikes with horn and hooves for 1-4/1/1.

Once per day, a glissan can cast a *sleep* spell. The spell affects a single creature, without restriction — including those of more than 4+4 HD, any undead, and "certain other creatures specifically excluded" from the effects of a normal sleep spell (see the spell description and the Monster Manual). Any target is allowed a saving throw; those who are normally subject to *sleep* spells save at -2.

Glissi are especially resistant (50%) to illusions, such as *phantasmal force* and related spells. Note that the illusion itself remains unaffected and may still be believed by others who fail to "see through it."

Glissi are absolutely and unswervingly committed to the cause of good, although those from the Twin Paradises or the Happy Hunting Grounds may have a lawful or chaotic bias. Glissi desire only peace, life, and happiness for all. They cannot commit evil acts.

Glissi are slim and delicate creatures with opalescent skin and large blue eyes. They have fine, silvery hair that forms a halo about their head, and a double pair of silver-white wings, shaped like a swallow's.

#### **Baltir**

MOVE: 9"/27"/21" (MC:B)

HIT DICE: 2+2

NO. OF ATTACKS: 2

DAMAGE/ATTACK: *By weapon type*

INTELLIGENCE: *High*

ALIGNMENT: *Chaotic good*

SIZE: *S (2' tall)*

LEVEL/X.P. VALUE: *V / 305 + 3/hp*

The baltiri are native to the planes of Olympus and Gladsheim. On the material plane, they may be hard to recognize, since they can assume different forms. A baltir can polymorph itself into a human or demi-human child, as the telperi and glissi do. It can also take the form of a cat, an otter, or a miniature lion (AC 5, MV 12", D/Att 1/1/1-2 and rear claws 1/1).

In addition to the powers that all galadur have, the baltir has two unique abilities. First, once per day it can make all others within 2" fall into a drunken stupor, unless they save vs. spell. The results of this power are listed under "greatly intoxicated" in the table on page 82 of the *Dungeon Masters Guide*. If anyone is even slightly drunk before the baltir uses its power, he or she becomes comatose after the baltir does so. Only a *neutralize poison* spell can remove the effects of the baltir's power; otherwise, the victim must recover as described in the DMG.

The baltir's second unique power is special resistance against magical control, including all charm-type spells — *command*, *hypnotism*, *suggestion*, and the like.

All baltiri love freedom and happiness, and they fight for the right of others to enjoy these things. Baltiri from Gladsheim choose chaos over good if they must make a choice.

In size, baltiri don't quite measure up; they're shorter than the rest of the galadur in their unpolymorphed state. Still, they are broad of build and look like handsome, muscular humans with somewhat flat faces and tufted pointy ears. A short, glittering, fiery red fur covers their entire body. They have broad wings and glistening lionlike manes that match the color of their fur. Baltiri have broad smiles and green or brown almond-shaped eyes.

#### **THE LOMENDUR**

It would seem that familiars from the middle planes — the lomendur — have a common origin, because they share a number of characteristics. They are perhaps better in tune with the largely neutral natural forces of the universe than are their good or evil counterparts, and evidence of this lies within the properties they share. In addition to those characteristics common to all supernatural familiars, the lomendur have both *infravision* and *ultravision* (range 6" for each). They can *detect good* or *detect evil* at will, and *speak with animals* as often as they please.

Lomendur also have a number of immu-

nities and special resistances, besides those shared by all supernatural familiars. None are harmed by acids, alkalis, normal fire, natural poisons, or petrification. They take half damage, at best, from magical fire or dragon-breath fire (save for no damage). Natural animals or plants harm them in two cases only: 1) if the plant or animal has been attacked, and 2) if it is under a spell of some sort (*charmed*, *summoned*, or otherwise enchanted). The lomendur's immunity to natural poisons extends to the poisons of giant creatures, but not to those of fantastic beings such as the wyvern or extraplanar creatures such as the imp.

Lomendur also have an "immunity" to certain weapons. Only a magical or stone weapon can harm them. And not all stone weapons will work; the particular type needed depends on the kind of lomendur being attacked.

Lomendur can swim at their walking or flying rate, whichever is faster. On land or in the air, they can use the same weapons that galadur do, but lomendur strike only once per round if they use a sword, and they gain no bonuses to hit with the bow. A lomendur's dexterity is 15, and its charisma is 13 with respect to other creature types.

#### **Tabur**

MOVE: 15"

HIT DICE: 2+3

NO. OF ATTACKS: 2

DAMAGE/ATTACK: 1-3/1-3 *or by weapon type*

INTELLIGENCE: *Average*

ALIGNMENT: *Lawful neutral*

SIZE: *S (2¼' tall)*

LEVEL/X.P. VALUE: *V / 275 + 3/hp*

Tabi come to the material plane from Nirvana. Each tabur can polymorph itself into three different forms from the following list of four: hawk (large), badger, dog (treat as a wild dog), and hare.

Though it can use weapons in its unpolymorphed form, a tabur prefers to strike with its hands, for 1-3 points of damage per hand. The damage figure is this high because the tabur has an instinctive knowledge of anatomy, like that of a monk. With its hand attack, it can stun or kill an opponent of size S as a first-level monk (1% chance to kill vs. AC 7, up to 4% vs. AC 10). Only magical weapons or those made of white flint can harm a tabur, and it can dodge magical missile weapons (but not a *magic missile* spell) the same way a monk evades non-magical ones.

The tabi have two powers that resemble cleric spells. First, they can *hold person* once a day, as a 2nd-level cleric, surpassing the actual spell because they can affect any number of eligible persons or creatures within range. Second, the tabur can *feign death* once a day for up to 14 turns.

Tabi are devoted to order and discipline untainted by cruelty or kindness; good and evil are irrelevant to them. They never let other considerations get in the way of true harmony and order.

## **THIEVES' GUILD™ SPECIAL OFFER!**

Gamelords, Ltd. is proud to announce the revised second edition of their acclaimed **THIEVES' GUILD™** basic rules — containing Basic Character Creation, rules for all sorts of thieving activities, and introductory scenarios — available by mail order from now until June 31, 1984 for the low price of only \$10.00! Order yours today!

**Gamelords, Ltd.**

18616 Grosbeak Terrace, Gaithersburg, MD 20879

At a glance, the tabi look like small, white marble statues. The creatures have perfect, symmetrical proportions; each appears to be an idealized version of the human or demi-human race of its master. Their calm and unhurried movements enhance their statuelike air, though they can muster extraordinarily quick and nimble movements at will. A tabur's hair matches the pure white color of its skin. When open, its eyes look like silvery pools. With eyes closed in meditation, while standing perfectly still, a tabur gives no hint of life at all.

**Orrek**

MOVE: 9" (1"-6")  
 HIT DICE: 3  
 NO. OF ATTACKS: 2  
 DAMAGE/ATTACK: 1-4/1 -4  
 INTELLIGENCE: *Very*  
 ALIGNMENT: *Neutral*  
 SIZE: S (2' tall)  
 LEVEL/X.P. VALUE: V/ 290 + 3/hp

Of the many orrekin that dwell on the plane of Concordant Opposition, few come to the material plane. When they do, they prefer to remain as inconspicuous as possible. Each orrek can take on three forms from the following list: salmon, owl (large), fox, and squirrel. In salmon form, the animal can move in fresh or salt water.

In its own shape, the orrek can burrow through rock or soil as quickly as an amber hulk. Other barriers may not stop it either,

since it can assume *gaseous form* once per day for up to 4 turns. This power works as the potion, but it applies only to the orrek, not to any personal effects it may be carrying. The orrek can also *trip*, *summon insects*, and *produce flame*, once per day each, no matter what form the creature is in; however, the latter two powers will not function underwater (when the creature is in salmon form), and even *trip* might not work as intended, although it could still be attempted underwater.

Only magical weapons, or those made of greenstone, can hit an orrek. "Greenstone" is any green rock that's hard enough to be made into a weapon — usually an inferior grade of jade.

Orrekin are devoted to balance; they tolerate other forces as long as none of them show signs of dominance. Orrekin believe chaos is foolish, law is pretentious, and good or evil is just a waste of time.

An orrek's general form looks human, but its body is squat and muscular, with rounded shoulders and long arms. Its hands are large and tipped with iron-hard, retractable claws. Orrekin are covered with short, soft fur, which is usually gray but may also be brown or black. Their glittering black eyes, short necks, broad teeth, and rather narrow heads suggest kinship to a rodent. But if this appearance evokes any negative reaction, this is usually soothed by the orrek's lively manner and pleasant, if simple, way of speaking.

**Quark**

MOVE: 9"/18" (MC:A)  
 HIT DICE: 2  
 NO. OF ATTACKS: 1  
 DAMAGE/ATTACK: *By weapon type*  
 INTELLIGENCE: *Average*  
 ALIGNMENT: *Chaotic neutral*  
 SIZE: S (2¼' tall)  
 LEVEL/X.P. VALUE: V/ 315 + 3/hp

Quarks hail from the ever-changing plane of Limbo. At the whim of themselves or their superiors, they come to the material plane, but natives of that plane may not recognize them readily because they change forms quite freely. Quarks use a limited version of the *shapechange* spell at will (as often as once per round), imitating any normal plant or animal of size S or smaller, down to the size of a housefly. They may also mimic natural, unrefined materials such as water, sand, or rock, taking the shape and size of an amount equal to their normal weight. As inanimate material, they have a sense of touch and can feel vibrations. In any other form, however, they only have the senses of the being they're mimicking. When *shapechanged*, they gain all the powers of the new form except for mental and magical abilities, in which cases they retain their normal abilities.

Quarks cannot imitate creatures from non-material planes, such as undead or natives of the astral or ethereal planes. They also cannot assume the form of humans,

**BATLEMATS™ AND MEGAMATS™**  
 THE PERFECT SURFACE FOR PLAYING OUT YOUR ADVENTURES

- Made of durable expanded vinyl with cloth backing. These mats come with a lifetime guarantee
- Completely Portable — they roll up for travel or storage yet lie flat when in use
- Makes the ideal aid for Game Designers
- Battlemats (23 ½" x 26") and Megamats (32" x 48") are available in Squares; staggered squares and hexagon patterns. Our new 21 mm. size makes it easy for players to convert 25 mm. scale to 5 ft. per sq/hex
- Spills wipe away easily
- Draw your layout right on the surface with water based overhead projection pens — then wipe away with water

Please check with your local dealer for the latest styles available

<b>BATLEMATS®</b>	9.00 ea	BM321	BM325	BM361	BM365
		(21 mm Sq)	(25 mm Sq)	(21 mm St. Sq)	(25 mm St. Sq)
<b>MEGAMATS™</b>	20.00 ea	BM416	BM421	MM521	MM525
		(16 mm Hex)	(21 mm Hex)	(21 mm Sq)	(25 mm Sq)
<b>PEN SETS</b>	4.00 ea	MM521	MM525	MM565	MM616
		(21 mm Sq)	(25 mm Sq)	(25 mm St. Sq)	(16 mm Hex)
		MM621	MM625	MM630	
		(21 mm Hex)	(25 mm Hex)	(30 mm numbered Hexes on black vinyl)	

Please add 1.00 (Canada 2.00) for shipping - California residents please add sales tax - Send check/money order to SLEUTH PUBLICATIONS - 689 Florida St - San Francisco, Ca 94110

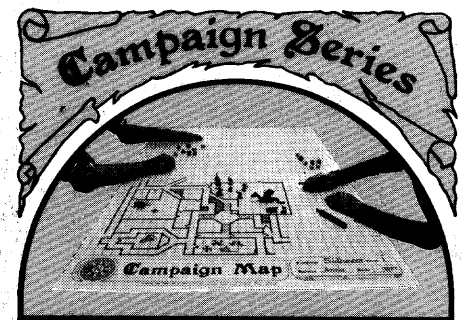

**GAME GRID SHEETS**  
 THE ORIGINAL ☆ THE LARGEST

**Campaign Map**  
 1 inch square grid 36" x 28" - \$1.25  
 36" x 50" - \$2.50

**Campaign Hex**  
 Double-sided hex sheet 36" x 50" - \$3.50

**Overlay Sheet**  
 Clear plastic re-usable sheet 36" x 50" - \$4.50

AT YOUR GAMESTORE OR FROM:  
**INDICIA ASSOCIATES**  
 5776 Broadway, Oakland, CA 94618

ADD Shipping and Handling charges:  
 Orders to \$10.00 . . . \$1.75  
 \$10.01 to \$15.00 . . . \$2.25  
 \$15.01 to \$25.00 . . . \$2.75  
 Over \$25.01 . . . \$3.25

Write for FREE Brochure.



"monsters" (fantastic or magical creatures), demi-humans, or humanoids. They can, however, imitate giant spiders or frogs that are size S or smaller. Anything the quark is wearing or carrying at the moment of transformation remains unchanged, dropping off or falling away as the change takes place.

In addition to the powers they share with other lomendur, quarks have the ability to cause *confusion* (as the druid spell, duration 2 rounds, saving throw applies) in one creature, by touch, once per day. Quarks can only be harmed by magical weapons or those made of obsidian.

Quarks acknowledge no rules, no conventions. They hate restraint and order, and they keep promises only if it pleases them to do so. For reasons unknown to mortals, it pleases some quarks to serve as familiars for chaotic masters.

Quarks look like tiny humans of slender build, with silvery skin and tangled, fuzzy hair that resembles a dandelion gone to seed. They have glittering, butterfly wings that change pattern and color daily or even hourly. Despite their strange appearance, they have a certain charm and beauty.

## THE BURZUGDUR

At one time, all burzugdur were evil humans who died and sank to the lower planes, where they became larvae of the same alignment. The most malign are chosen to form imps, quasits, or nalg, depending on the flavor of their evil.

All burzugdur have the abilities common to supernatural familiars. They also have *infravision* (6" range) and can *detect evil* (range 12") at will. Fire cannot harm them, and the only weapons that can harm them are magical ones or weapons made of special metals (cold iron for quasits, silver for imps; see the Monster Manual for complete descriptions of these types). All burzugdur are venomous to one degree or another. Each has 14 dexterity and 8 charisma. Upon first examination, they may seem to have a less formidable set of powers than other supernatural familiars — but what they lack in quantity, they make up for in quality.

Three types of burzugdur can become familiars: the imp, the quasit, and the nalg. The imp and quasit are described in the Monster Manual, but their colorations and some other details are not given. Imps are dull red to black in color, with yellow eyes. Quasits are of a greenish hue that ranges from pallid to nearly black. They have red eyes, and yellow claws and horns. Imps have a diabolic point of view, while quasits are demonic. However, imps from Acheron care more for law than evil, and quasits from Pandemonium prefer chaos to evil if forced to choose.

### Nalg

MOVE: 9"/21"

HIT DICE: 3

NO. OF ATTACKS: 3

DAMAGE/ATTACK: 1/1/1-3

INTELLIGENCE: *Low*

ALIGNMENT: *Neutral evil*

SIZE: S (2' tall)

LEVEL/X.P. VALUE: V/ 325 + 3/hp

Nalgs are little horrors from the planes of Gehenna, Hades, and Tarterus. They are minor demons that commonly serve as familiars to evil clerics or magic-users, though they may be found on the material plane for other reasons. Each nalg can take the forms of two of the following creatures: stirge, horsefly, poisonous snake, or weasel. In the form of a horsefly, a nalg flies at 18", has an AC of 0, and renders a painful but harmless bite.

In its natural form, the nalg attacks with claws and teeth. Its bite does 1-3 points of damage, and a victim must save vs. poison each time he is bitten; if a saving throw is failed, the victim will be blinded for 2-12 rounds thereafter. This blindness attack only affects a given target once during an encounter; subsequent bites will do damage, but will not extend or worsen the blindness. However, if a nalg chooses to do so (or is ordered to do so by its master), it can hold onto a victim after a successful bite and drain blood at 1-3 points per round thereafter. The blood drain will last until the nalg is killed, until it drains 12 hit points worth of blood, or unless it detaches itself at some point previous to either of

those occurrences. While it is attached, the nalg's armor class is worsened to 8, with respect to attacks made upon it by anyone other than the victim of the blood drain. During the nalg's blood-draining attack, the victim must save vs. poison in every round or be blinded for 7-12 rounds thereafter — assuming the victim lives that long. After draining blood, the nalg must rest for a day before it tries to do so again, regardless of how much blood it drained.

The nalg can use *phantasmal force* as the magic-user spell once per day. Of course, it must concentrate on the illusion to maintain it. A nalg is harmed only by magical weapons or those made of nickel or a nickel alloy.

Like the imp and quasit, the nalg cares nothing for the master it serves. It performs as a familiar partly out of fear and partly because of its lust for power. A nalg strives to bring woe to others and power to itself. It is little concerned with such abstractions as law and chaos, though some nalgs have a bias in one or the other of those directions.

In its usual state, the nalg is a small hairy creature with clawed hands, froglike legs, and two-toed, webbed feet. It has a long, foxlike muzzle filled with razor-sharp teeth. Dirty pink skin surrounds its baleful yellow eyes. Elsewhere, its pink mottled hide is partially covered with sparse, coarse hair of a dull black or dirty white color. Unless it has gorged itself recently, the nalg looks somewhat like a skeleton.

## Natural familiars

The special familiars of the material plane are a diverse group, varying widely in their characteristics and the powers they confer upon their masters. The similarities between them are (from the spellcaster's point of view) more negative than positive. They do not add their hit points to those of their master as do normal familiars, and they do not confer regenerative powers as do supernatural special familiars. On the other hand, the master of a natural special familiar does not lose hit points or levels if the familiar is killed. The natural familiars are less concerned with alignment behavior than their extraplanar counterparts; they are natives of the material plane, and, as such, are more familiar with the shades of gray that abound in the material plane's alignment structure.

While natural familiars will serve more or less faithfully, they are free-willed beings and can think for themselves. They will have had lives of their own before taking up service, and ideas of their own, which may be at variance with the outlook of their master even if they happen to be an exact match in alignment. They are in fact rather like henchmen and should be considered as such in cases that call for morale and loyalty checks. While normal familiars are willing (or at least unwitting) slaves or pets, and supernatural special familiars have other loyalties and purposes, the natural special



**GLADIATORS**

**EXCITING NEW PLAY-BY-MAIL GAME!**

VIVID MOMENT-TO-MOMENT MEDIEVAL  
COMBAT AGAINST MAN, BEAST, AND MAGICKS  
RANKINGS SHEET AND 12 PAGE NEWSLETTER  
WITH EACH TURN.

**\$1.40 PER TURN!**  
WRITE US AND REQUEST OUR FREE  
NO OBLIGATION SET UP AND RULES.

WRITE TO: **HAND CRAFTED COMPUTER GAMES**  
1700 S. COLLEGE #23 • TEMPE, AZ 85281  
(602) 894-6181

familiars occupy an intermediate position between these extremes.

There are few strings attached if a magic-user obtains the service of a natural special familiar. In general, the familiar will require good treatment, up to and including gifts of magic items they can use (there are a few) if their loyalty is to be assured. A natural special familiar will leave its master if conditions become intolerable, and the effects of this will be the same as if it had been sent away (see page 44 of the DMG). If the familiar is killed, there is no ill effect on the magic-user beyond the loss of any special abilities the familiar had bestowed upon its master. However, the chance for the same magic-user to get another familiar of the same type is drastically reduced. The kindred souls of the slain familiar will know instinctively that one of their fellows met a tragic end while serving that magic-user, and they will understandably be reluctant to follow the same course. If another familiar of the same type as the slain one is indicated on a later casting of the *find familiar* spell, the creature will have a 100% magic resistance (instead of its normal resistance, if applicable) that must be overcome before the creature will hear the call.

As pointed out earlier in the section on supernatural familiars, any creature is allowed a saving throw to escape the effect of the *find familiar* spell. In the case of a natural special familiar, this represents the chance that the creature will have serious doubts about entering into service. Life as a familiar can offer hazards as well as rewards, if the call comes from an adventuring spellcaster. On the other hand, life with a sedentary magic-user could be boring and unsatisfying. Perhaps the creature being called finds something objectionable in the behavior or appearance of its would-be master; similar alignments don't necessarily make for a smooth relationship. Even potential familiars with no other commitments and little to lose might be reluctant, for reasons that may be fully known only to them.

It isn't necessary to postulate a different type of natural special familiar for every spot on the alignment spectrum, as was the case for supernatural familiars. Being residents of the material planes, natural familiars generally have some inherent flexibility where alignment is concerned. For instance, although most brownies are equally concerned with law and good, some put a greater emphasis on obedience and order than on happiness. The type of natural familiar that can be obtained by a magic-user of a certain alignment is as follows:

LG to LN	Brownie
LE to NE	Durocib
Neutral	Haudhla
CE to CN	Veeru
CG to NG	Pseudodragon

The brownie and the pseudodragon are described in the Monster Manual. Descriptions of the others are given below. Each type of familiar has its preferred habitat, but since they are hardy and (in the case of

the individuals summoned) adventurous, they might be found anywhere. The DM must rule on this, but it seems reasonable that a natural special familiar would be summonable anywhere in the imaginary world of the campaign, with the possible exception of such places as polar ice caps and the middle of an ocean. In most cases it will not be too difficult to argue that some trick of fate has brought one of these potential familiars within range of the spell. After all, the lives of adventurers abound with strange circumstances and odd coincidences, of which this might be a relatively minor one.

#### Durocib

FREQUENCY: *Uncommon*

NO. APPEARING: 2-12

ARMOR CLASS: 7

HIT DICE: 1/2

% IN LAIR: 20%

TREASURE TYPE: *See below*

NO. OF ATTACKS: 1

DAMAGE/ATTACK: 1-2

SPECIAL ATTACKS: *See below*

SPECIAL DEFENSES: *Save as 7th level thief*

MAGIC RESISTANCE: *As above*

INTELLIGENCE: *Low (high cunning)*

ALIGNMENT: *Neutral evil*

SIZE: *S (1 1/4' tall)*

PSIONIC ABILITY: *Nil*

LEVEL/X.P. VALUE: *III/ 60 + 1/1hp*

Though these nocturnal creatures are most common in the trees of temperate to subtropical lands, they are adventurous and may be found almost anywhere after dark. Despite their small size, they are feared for their malevolence and for the effects of their gaze. The durocib's gaze affects all types of creatures that are subject to the magic-user *charm person* spell. Anyone who meets the gaze of a durocib must save vs. spell or become temporarily insane. Those afflicted will acquire a mental sickness of an immediately debilitating type (choose at random from the table on page 83 of the Dungeon Masters Guide) such as hebephrenia, catatonia, or hallucinations.

Victims of the gaze must immediately save vs. spell a second time, and if this save is also failed, the victim is not afflicted with insanity but instead will fall under the mental control of the durocib, with effects identical to those of a *charm person* spell. The victim will not be visibly changed, and while receiving orders or carrying them out will act and appear normal. The durocib must remain within 1" of its victim to maintain this control, and usually accomplishes this by perching on the victim's shoulder.

The temporary insanity will last for 2-8 hours, and the victim will not be subject to the durocib's gaze again for one day after the insanity ends. Those who fall victim to the mental control effect of the gaze have the same chance of breaking free as if the victim was under the influence of *charm person*. As with the insanity effect, a victim

who breaks the *charm* cannot be affected again for at least one day afterward.

Usually slow and deliberate in its movements, the durocib is capable of sudden darts and lunges, and has an uncanny ability to sense the intent of an enemy an instant before the enemy takes any action. Because of this characteristic, the durocib makes saving throws as a 7th-level thief. The creature has in addition a number of thieflike abilities, all performed with the same chance of success as a 7th-level halfling thief. They can *move silently*, *hide in shadows*, *climb walls*, and *detect traps*; the latter ability is limited to snares and pits only. Because of their keen senses, durocibs are never surprised and can surprise others on a 1-4. Though they are clever with bolts and latches and can use simple tools, durocibs are unable to become skilled with weapons.

These small horrors are fierce if cornered, and will always attack when they have a clear advantage, but are also cowardly. They accomplish less evil than they might because they are so petty and greedy. Durocibs have a language of sorts, which can be understood by someone using *comprehend languages* but not otherwise learned or used by other creatures. Very seldom will a durocib make the effort to learn the common tongue, and those that do are never fluent in it; their harsh hisses and guttural sounds make them very difficult to understand. Durocibs take great delight in tormenting



**THE COMPANIONS**

**ROLE PLAY,  
CAMPAIGN,  
AND ADVENTURE  
GAME AIDS**

**ISLANDIA CAMPAIGN SERIES:  
MODULAR ADVENTURES  
FOR ALL FANTASY  
ROLE PLAY SYSTEMS**

- THE CURSE ON HARETH
- PLAGUE OF TERROR
- STREETS OF GEMS
- BROTHERHOOD OF THE BOLT

50-page booklets  
Fabulous maps to play on  
Thrilling descriptions  
New treasures & traps  
Color wilderness maps

**P. O. BOX 843 BATH, ME 04530**

the weak and helpless, when they can get away with it; in fact, little else can hold the attention of a durocib for any length of time.

If a durocib scores a hit with its bite, it can choose to hold onto its victim and drain blood at the rate of 1-4 points per round thereafter. The durocib will maintain its hold until it chooses to retreat, until it is killed or rendered unconscious, or until it drains 14 hit points worth of blood.

Durocibs enjoy hoarding jewelry and gems, and may even wear some baubles. There is a 20% chance that a durocib will have a small gem or piece of jewelry in its lair.

Durocibs resemble tailless, round-headed monkeys, small but stockily built. They are covered with short, dense grey fur with a pattern of dark grey or black bands in it that is unique to each durocib. They have large, reddish-brown eyes that exude a reddish glow in the dark when they are employing their infravision (range 12").

A magic-user who acquires a durocib as a familiar can receive all the sensory information the creature gathers, through a telepathic link that has a range of 12". The master also gains an 18 dexterity and a bonus of +1 on all saving throws.

### Haudhla

FREQUENCY: *Rare*  
NO. APPEARING: 40-100  
ARMOR CLASS: 5  
MOVE: 15"  
HIT DICE: 1/2  
% IN LAIR: 10%  
TREASURE TYPE: C  
NO. OF ATTACKS: 1  
DAMAGE/ATTACK: *By weapon type*  
SPECIAL ATTACKS: *See below*  
SPECIAL DEFENSES: *See below*  
MAGIC RESISTANCE: 25%  
INTELLIGENCE: *Very*  
ALIGNMENT: *Neutral*  
SIZE: *S (1¼' tall)*  
PSIONIC ABILITY: *Nil*  
LEVEL/X.P. VALUE: *III / 65 + 1/hp*

The haudhli are creatures of nature, remaining close to plants and the earth wherever they dwell. They live in small hills or mounds, each family of 2-5 having its own burrow with a concealed entrance. A community of haudhli will normally have 20 families. Though they may dwell anywhere because of their hardiness, haudhli are most likely to live near the habitations of men — but the humans may not be aware of them. Because they are swift afoot and can make themselves essentially invisible in natural terrain, they may be locally common in even heavily populated areas without ever being found out.

The haudhli are not friendly with the larger races (to them, even a halfling is large), particularly if an intruder or group of intruders discovers their lair. If they are discovered and approached, they will expect and perhaps bluntly demand many apolo-

gies for the intrusion. Haudhli love precious metals and gems, and a community will often have its own treasure trove. Sometimes they can be bribed with gems or jewelry.

Haudhli are handy with simple tools, and can fashion small swords and bows and arrows with which to defend themselves. Their swords do 1-3 points of damage vs. S or M creatures, 1-2 vs. opponents of size L. Their bows have half the range of a short bow; arrows do 1-2 points of damage vs. S or M creatures, and only 1 point against size L foes. The haudhli use no other weapons, but may employ traps, especially in the vicinity of their lair.

A haudhla can *speak with plants* once per hour, and once a day it may employ *detect snares & pits*, *predict weather*, *purify water*, *obscurement*, *snare*, and *audible glamor*. All of these spell-like powers are performed at the eighth level of ability. In addition, haudhli can fall from any height or pass over any surface as if using the psionic discipline *body equilibrium*. They can survive extreme temperatures (-20 to +120 degrees F.) with no protection, but this resistance is not proof against normal flame or magical heat or cold of any sort.

If a neutral magic-user acquires the services of a haudhla as a familiar, the spellcaster gains the haudhla's resistance to magic and to extreme temperatures, as well as its *body equilibrium* ability — but these powers are conferred on the master only if master and familiar are touching. The magic-user may also receive telepathic communication of all the haudhla sees, hears, and senses, as long as master and familiar are no farther than 12" from each other.

Haudhli appear as minuscule humans with sharp and somewhat homely features, with skin color ranging from brown to dark brown, and silvery-blue hair. They wear clothes of green, brown, or grey hues. They speak the haudhla language plus the tongues of gnomes, pixies, sprites, halflings, and the common tongue.

### Veeru

FREQUENCY: *Very rare*  
NO. APPEARING: 1  
ARMOR CLASS: 2  
MOVE: 9"/21"/18" (MC:B)  
HIT DICE: 1+2  
% IN LAIR: 5%  
TREASURE TYPE: Q (x10)  
NO. OF ATTACKS: 1  
DAMAGE/ATTACK: 1-2  
SPECIAL ATTACKS: *Poison bite, singing*  
SPECIAL DEFENSES: *Transparency*  
MAGIC RESISTANCE: 30%  
INTELLIGENCE: *Average*  
ALIGNMENT: *Chaotic (see below)*  
SIZE: *S (3' long)*  
PSIONIC ABILITY: *Nil*  
LEVEL/X.P. VALUE: *IV/ 200 + 2/hp*

Veeru (singular and plural are the same word) roam widely, but when encountered

are usually near water. They are elusive and generally avoid direct contact with other intelligent creatures. Veeru make floating nests of reeds to sleep in, or lair in trees or caves if they aren't near water or reeds are unavailable.

A veeru bites with its long, toothy jaws for 1-2 points of damage per hit. Any creature bitten by a veeru must save vs. poison or become *confused* for 13-24 hours thereafter. The veeru's other weapon is its song. Once per day it can sing a tune with its chimelike voice that will cause all within 3" to be affected as if by an *Otto's irresistible dance* spell. Anyone within the area of effect, or anyone who enters the area while the song is going on, is allowed a saving throw vs. spell to avoid the effect. The veeru must halt its song if it is hit in combat or otherwise distracted, and in any event it cannot keep up the singing for longer than three rounds. The *dance* effect on victims lasts for 2-5 rounds beyond the time when the veeru stops singing.

Like the pseudodragon (to which it is loosely related), the veeru can see invisible objects. It can become effectively invisible (80% undetectable, like the pseudodragon) by making itself transparent. In this state, a veeru still reflects light, and when seen from certain angles appears as a shimmering rainbow of colors. Those able to detect invisible objects who succeed in the attempt will see the veeru in its true form, and not as a rainbow of colors. Veeru are near-perfect mimics, able to imitate words, short phrases, and bird calls with 90% accuracy. They do not learn languages; communicating instead (as does the pseudodragon) through a form of limited telepathy.

All veeru are chaotic and unpredictable in actions and motives. The majority (55%) are neither good nor evil, 40% are of evil inclination, and 5% are chaotic good. Evil veeru like to mislead those foolish enough to venture into swampy places, and they sometimes work in concert with will-o-wisps.

If a chaotic evil or chaotic neutral magic-user acquires the services of a veeru as a familiar, it will be a type that matches the master's alignment. (No chaotic good veeru will ever come as a familiar.) If master and familiar are touching, the magic-user gets the benefit of the veeru's magic resistance, and the creature can transmit telepathically whatever it senses, as long as master and familiar are no farther than 24" apart.

In its natural (opaque) form a veeru appears much like a miniature gold dragon with long, slender, bat-like wings. Its scaly hide is gold, and it has glowing green eyes.

**Editor's note:** This article can be used in conjunction with "A cast of strange familiars" (issue #84) in a total revamping of the *find familiar* spell. Or, these familiars can be used without also using the "non-special" ones from the earlier article. And, last but not least, these creatures can simply be used as new monsters — which ought to be absolutely *un*-familiar to any characters who encounter them! □



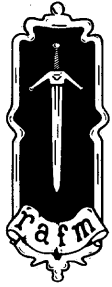

# Rafm Company, Inc.

19 Concession St.,  
Cambridge, Ont., Canada  
N1R 2G6  
1-519-623-4832



**Shipping, Postage and Handling**  
U.S.A. and Canada please add \$2.00  
Others please add 15% Surface or 30% Airmail  
**Minimum Handling Charge...\$2.00**

Send \$2.00 for 1984 catalogue.

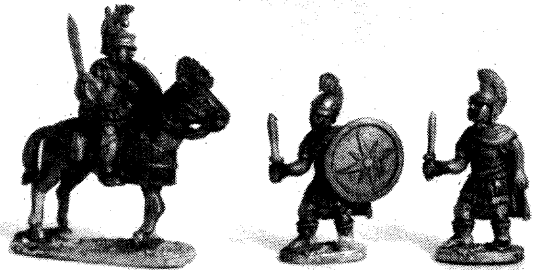

AH-21

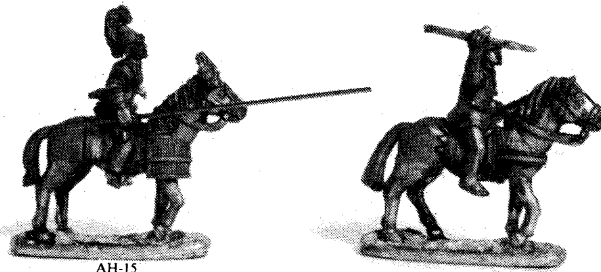

AH-15

AH-17

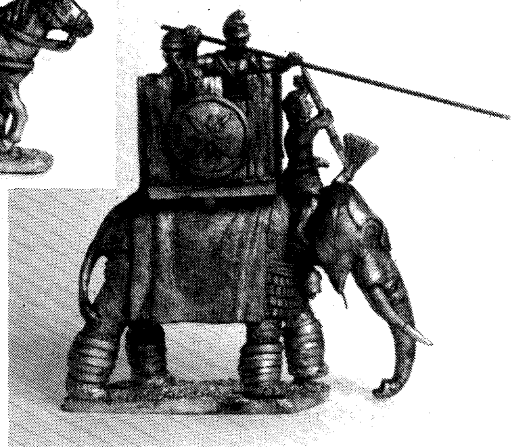

AH-19

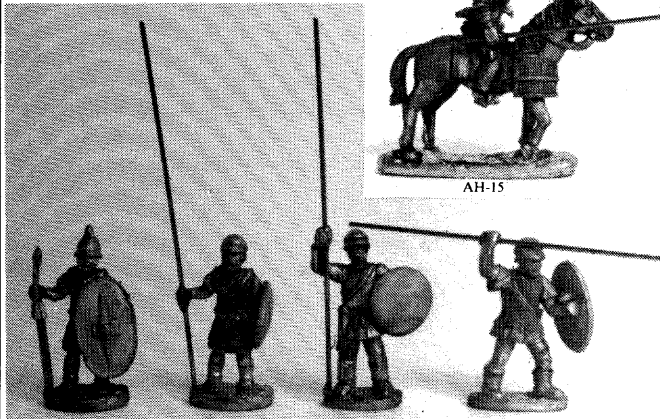

AH-1

AH-2

AH-6

AH-13

From Rafm Miniatures:

## ARMIES OF THE HELLENISTIC PERIOD

AH-1	Imitation Legionary with Thracian Helmet with scutum, pilum (6)	4.00
AH-2	Pikeman in Chainmail with aspis (6)	4.00
AH-3	Front Rank Pikeman with aspis and thracian helmet (6)	4.00
AH-4	Hypaspist with macedonian helmet and large shield (6)	4.00
AH-5	Pikeman in quilted armour with aspis (6)	4.00
AH-6	Pikeman in Asian dress with pilas helmet and aspis (6)	4.00
AH-7	Kyrtii Slinger with light shield (6)	4.00
AH-8	Elite Guard Infantry, spear, large shield (6)	4.00
AH-9	Elyriaan infantry with thureos (6)	4.00
AH-10	Elyriaan archer (6)	4.00
AH-11	Thracian Thureophoros (6)	4.00
AH-12	Thracian peltast (6)	4.00
AH-13	Thorakites (6)	4.00
AH-14	Light equipped Javelinman (6)	4.00
AH-15	Extra Heavy companion cavalry (3)	4.00
AH-16	Agema cavalry (3)	4.00
AH-17	Light Cavalry (3)	4.00
AH-18	Illyrian Light Cavalry (3)	4.00
AH-19	Armoured War Elephant with Howdah, 2 crew and Mahout	12.00
AH-20	Indian Elephant with Mahout	7.00
AH-21	Command Group I officers, mtd (1) and dismounted (2)	4.00
AH-22	Command Group II - Foot Standards and Musicians (2ea)	4.00
AH-100	Hellenistic Heads (36) (6 types)	3.00
AH-101	Auxiliary Heads (36) (6 types)	3.00
AH-102	Weapons (24) (4 types) Kopis, Shortsword, Rhomphaia, Pilum	3.00
AH-103	Missile Weapons (24) (4 types) Javelin, Sling, Stave bow, Composite bow	3.00
AH-104	Heavy Shields (24) (4 types) Aspis, Scutum, I.e. Hoplite, Thureos	3.00
AH-105	Light Shields (24) (4 types) Thureos, Small Round, Wicker, Crescent	3.00

Armies of the Greek Age, following the death of Alexander The Great.

A top quality historical range, designed to permit maximum versatility for you, the gamer. The ancient figures have separate heads, weapons and shields allowing whatever figure requirements you desire for your army.

*You build your army to your specifications!  
You have PRIDE in your army!*

The Hellenistic's have 22 figure packs and 6 accessory packs which allows the serious gamer the maximum choice.

## FOR CANADIANS ONLY\* Ral Partha Fantasy

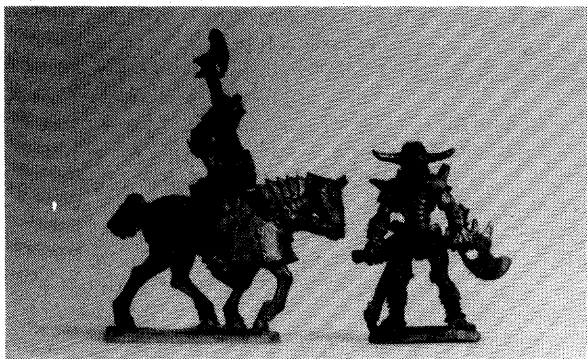

01-125

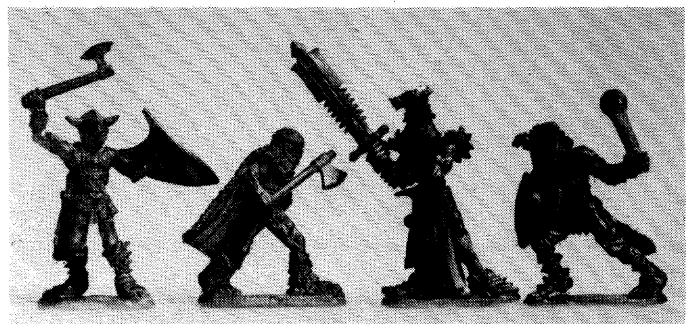

01-124

### Personalities

25 mm

01-120	Cutthroats (4)	4.00
01-122	Bandersnatch and Jub Jub Bird	4.00
01-124	Warriors of Chaos (4)	4.50
01-125	Champion of Chaos mounted and on foot	4.00
01-126	Lord of Chaos mounted and on foot	4.00

\* Due to licensing requirements, this range is only for sale to Canadian customers. Others please inquire: Ral Partha, 5938 Carthage Court, Cincinnati, Ohio 45212

# The warrior alternative

## Generating non-magical characters for the DQ game

by Craig Barrett

Of all role-playing game topics, my favorite is fantasy. I enjoy working with simulations of magic, provided that the magic is treated as something special and is used in moderation. This statement seems contradictory in light of the fact that the fantasy RPG I have worked with most frequently is the DRAGONQUEST™ adventure game. Contradictory, because the DQ game system not only encourages every player to make his character a practitioner of magic but actually penalizes a player who doesn't.

It's not that the DRAGONQUEST game doesn't allow for non-magical characters, because non-Adepts abound. For example, non-magical characters are described in the game rules (see 31.0 and 31.4), in game supplements (from "Camp of Alla-Akabar" to "Blade of Allectus"), and even in Gerry Klug's article "DragonNotes" (ARES™ Magazine, issue #11), which deals with the issue of randomizing NPCs. So, nothing in the rules prohibits a player's character from being a non-Adept, but nothing encourages

to start with some Ranked skills besides languages may find this option intriguing.

If a player examines the game rules (up to Rule 8.7) for resources available to his character, he realizes that his character must pay *something* in order to be initiated into a magical College. The most valuable clue to this *something* is found outside the regular DQ game materials, in Chaosium's *Thieves' World*. When Eric Goldberg, one of the original DQ game designers, adapted the game to fit the universe of Robert Asprin's fine *Thieves' World* anthology series, Goldberg directly contravened Rule 34.5, which prohibits Adepts from learning the magic of a College other than his own. The revised procedure goes like this: In exchange for a six-month term of study and 5,000 Experience Points (EPs), the initial magic of a College of the same alignment as a character (see 34.1) can be learned; for a twelve-month term of study and 7,500 EPs, the initial magic of a College of a different alignment can be learned.

In this setup, it's easier to learn the magic of a different but similarly aligned College than it was for the Adept to learn the magic of his original College, because, at this point, the character is building on a familiar foundation. A non-aligned College is more difficult since the character is hampered by the training gained from his first College. By splitting the difference between the two costs — say, a nine-month term of study and 6,500 EPs — we arrive at the initiation cost for a character's first magical College.

Let's suppose that, while a character's classmates are busy with their spells and potions, he decides to go a different route. The character knows that he can always be initiated into a magical College later (for nine months of study and 6,500 EPs); however, he currently wants an education that offers more tangible survival benefits. Instead of entering a school for magic, he enters a different kind of school.

Unless the Gamemaster has created a highly detailed DRAGONQUEST world, a player does not have to worry about identifying this other school that his character attended, any more than he would if all characters attended a magic-teaching school. Instead, this player should follow the standard Character Generation rules until he reaches Rule 8.5; at this point, he stops. The player now has nine months and 6,500 EPs to spend on his character for the development of skills other than magic.

These EPs can't be spent indiscriminately. Because players don't want to mess



Those who've played the DQ game know what I mean. Reading the Character Generation rules leads the player face to face with Rule 8.7: "The player may want to . . . choose a college of magic for his character (see 34). . . ." But what if the player doesn't *want* to choose a College for his character? Tough. No alternative is offered; no compensation for not making a character an Adept is provided. The rules trot blithely on, and the player is left wondering why such an empty opportunity exists.

it, either. The offer of a magical College for one's character is a gift; forgo the gift, and nothing is offered in its place.

This situation doesn't seem fair, because the courage required to engage in a DQ campaign without the recourse of personal magic deserves some reward.

Hence, the "warrior alternative" offered in this article. This option provides immediate martial privileges for players who are willing to sacrifice intermediate-range magical advantages for them. Players who wish

up the play balance, some restrictions are in order (see 87.7).

First, every character who chooses the warrior alternative expends 2,500 EPs on characteristic points: either for one Fatigue Point, which raises the character's total no higher than 23 and has no effect on Endurance (see 5.3), or for 3 Perception Points, which are added to his initial 8 PC points.

Second, a character selects one skill from Chapter VII that he majored in and expends sufficient EPs to raise that skill to Rank 2. Then, he selects a skill he minored in and expends enough EPs so that the skill is at Rank 1. Players should be able to defend skill choices if the Gamemaster challenges the relationship of these selections to the character being role-played. A school for Assassins, for example, might provide a supplementary course in Spying or Courtesy (the character has to get close to his target if he's to kill him), but not one in Alchemy or Navigation. A school for Thieves could also train Merchants (this way, a character could double as a fence for stolen goods), but not Military Scientists (though soldiers are also foragers and, therefore, might minor as Thieves).

Since the warrior alternative is the point of discussion here, choices for a major skill should be limited to Assassin, Beast Master, Military Scientist, Navigator, Ranger, Spy, and Thief. Neither the major nor the minor skill should be a language.

Once the character has selected his major and minor skills, he selects three weapons consistent with these skills and expends sufficient EPs to earn Rank 2 with one of them and Rank 1 with each of the other two. Thus, an Assassin *must* select either the sap or the garotte as a tool of his trade, and he probably wouldn't choose a broadsword or shield, while a Military Scientist (particularly one from a family of the Greater Nobility) probably would. These weapon choices shouldn't be unduly restricted, but should remain reasonable.

When weapons have been selected, all of the character's 6,500 EPs may have been used. Of any EPs remaining, only up to 500 can be held in reserve to be added to the EP bank once the procedures in Rule 8.7 are completed. Any EPs in excess of this amount are permanently lost. Remaining EPs can now be spent for more Fatigue or Perception points, for Stealth to Rank 1, for Horsemanship to Rank 1, for Hunting to Rank 1 (see Paul Crabaugh's article in DRAGON® Magazine, issue #78, p. 84), or for any affordable combination of these.

When remaining EPs have been spent, the player proceeds with Rules 8.5, 8.6, and 8.7. EPs acquired under Rule 8.5 can be spent in any manner desired during this process. (I recommend immediately using the bargain price of 100 EPs for one skill — Rule 8.6 — for a language skill. Under Rule 49.6, this means a character begins play with Rank 8 in that language. He already has 7 to 10 Rankings in other skills, so why pass up this chance if 8.5 has given him the EPs to spend?)

If the character is human (this variant is mainly designed for humans), he is credited with being able to read, write, and speak Common at Rank 8 (see Rule 49.0, paragraph 3, and Rule 49.6).

When the character generation process is completed, a player adds to the EP bank those EPs he's been holding in reserve from his character's "education fund" of 6,500 EPs. Finally, the player assigns his character a name (see 8.8), and his work is done.

Gamemasters should deal with the newly created non-Adept in a liberal fashion and should be patient as the non-Adept works out the duties of having sudden Rank. An Assassin of Rank 2, for example, must pay 700 Silver Pennies per year as "hush money" and such (see 51.9). Since the character won't be able to afford that sum of money right away, the Gamemaster should give the new Assassin plenty of time to gather the needed funds during his first year of operation. The Gamemaster must treat all skills with similar generosity.

One final note: These Ranks should be seen as fair just compensation for an audacious character who is willing to brave the dangers of a DRAGONQUEST world without the benefit of personal magical powers. By the character's abstinence, he's contributing to the value of the magic being used by others; therefore, he should be given a little bit of an edge in other areas. ☐

Dragon (NEW)

Sword of Bingham

Crystal Ball in the Dragon's Claw  
Specify blue or red crystal ball

actual size

Five pewter collectibles on goatskin lace only from

**AMULET**®

Send \$7.75 US for each  
(Mich. residents add 4% tax)  
to: **AMULET**

P.O. Box 99067 Dept. DM Troy, MI 48099

Allow 3 to 5 weeks  
Satisfaction Guaranteed.

# RECON

The Roleplaying Game of the Vietnam War.  
Because the Last American Heroes Weren't  
in World War II.

## H. G. Wells Award Nominee for Best Roleplaying Game of 1982.

"The designer has done a masterful job in organizing and summarizing this material and fleshing it out with interesting tidbits obviously gained from combat experience."

Shelby L. Stanton former Special Forces recon and author of "Vietnam Order of Battle" reviewed in "Fire & Movement."

"...realistic and efficient, actually staying in the desirable border between realism and playability."

Abyss

"The accent is very firmly on playability."

Military Modelling

"On what fun napalm is!"

White Dwarf

"Since its introduction, Recon has become the basis for gaming other modern military operations, including real and hypothetical coups and terrorist activities."

Dana Lombardy, Analog

Send long SASE for info on modules, supplements, and miniatures to:

RPG, Inc. P.O. Box 1560-A, Alvin, Tx 77512-1560



# Five new enchanted objects

## Magic items you won't find in the AD&D® books

Many AD&D® game campaigns reach a state where the Dungeon Master and the players become too accustomed to the magic items listed in the official rules. More than 200 are given in the DMG, and while it may be virtually impossible to bring all of them into play, there's nothing to prevent players from reading the descriptions, either because they want to be "one up" on the DM, or maybe simply because they're interested. Either way, the end result is a lack of suspense and surprise that takes away some of the appeal of the game.

One way for a DM to get around this problem is to modify the appearance or nature of magic items, so that players' advance knowledge of the DMG doesn't do them any good. Another way is to use entirely new magic items — and that's where this article comes in. Here's a selection of enchanted objects that DMs can choose from to add an element of the unexpected to the next NPC or treasure trove that adventurers come upon. And even these can be modified, to foil players who might see this article before their characters have a chance to experience the items described in it. Taking a good idea and making it better (to suit your needs) is the essence of creation, and that's what the AD&D game is all about.

### *Staff of the Couatl*

by Pat Reinken

The *Staff of the Couatl* is a device much appreciated and used by good clerics, particularly those who worship the few good-aligned deities of the Central American myths. The lawful neutral clerics of Quetzalcoatl, however, may use staves of this sort normally.

A *Staff of the Couatl* is about 7' long, with the top 3' of the *staff* fashioned in the shape of a winged couatl. Such staves are usually made from precious materials such as ivory over a silver core, and are magically strengthened so they can be used in combat (as quarterstaves). This powerful *staff* has the following abilities:

1) It can be used to *summon* one couatl per month to serve the needs of the cleric possessing the *staff*. The couatl will have randomly determined hit points and psionic abilities. It will light on behalf of the summoning cleric until the opponent is vanquished or escapes, or until the user of the *staff* commands the attack to cease. If the

couatl is summoned to fight against insurmountable odds, or if the combat does not seem to be favoring the side of the couatl and the cleric, the couatl will wrap its tail around the cleric and transport both of them to a place of safety elsewhere on the Prime Material Plane (by traveling through the Ethereal Plane). This destination is not under the control of the cleric. In any event, the couatl will vanish back into the Ethereal Plane 5-8 turns after being summoned, or sooner if the cleric commands it. This power may only be used by lawful good clerics or clerics who worship Quetzalcoatl.

2) So long as the *staff* is carried, the cleric gains a +2 bonus to his saving throw vs. magical effects in general, and a +4 bonus to his save vs. all poisons. These bonuses are cumulative with those offered by other devices, as per a *ring of protection*.

3) The *staff* may be used to effect the casting of certain spells: *detect evil* and *snake charm* each three times per day; *neutralize poison* and *sticks to snakes* each once per day; and *wind walk* once per week. All spell effects are at the 8th level of ability.

4) The *staff* is +1 to hit and damage when used in combat.

A non-good, neutral-aligned cleric (lawful neutral, chaotic neutral, or neutral evil) who grasps the *staff* will not be harmed, but cannot use any of its powers (except for clerics of Quetzalcoatl, as noted for power #1). An evil cleric who picks it up will take 2-5 points of damage each round the *staff* is held. If a cleric of Tezcatlipoca, Quetzalcoatl's chief rival, is struck by or picks up this *staff*, all damage received is doubled, and that cleric must save vs. poison each round the *staff* is grasped or be slain.

Experience Point Value: 7,500

Gold Piece Sale Value: 20,000

### *Scepter of Defense*

by Susan Lawson

The *Scepter of Defense* is a rod like instrument about 3' long, with a handgrip on one end. It may be used by all fighter classes, clerics, druids, thieves, assassins, and monks as a parrying device. When its user is in combat against a human, demihuman, or humanoid opponent, the *scepter* may be wielded to cause all attacks against the user to be made at a -4 penalty to hit. The *scepter* can parry two attacks in one melee round, regardless of the user's

level, so long as the attacks come from the user's front and sides. Attacks made from the rear cannot be parried.

The *scepter* is useless as a parrying implement against non-humanoid creatures like dragons or black puddings, against blows from humanoid creatures larger than an ogre, and against attacks from creatures using weaponless combat (such as ogrillons, trolls, or wrestlers).

The user's strength bonus to hit (if any) may be subtracted from an opponent's chance to hit the *scepter's* wielder. No sort of attack can be made in the same round that the *scepter* is used as a parrying device.

The *scepter* will function as a +1 club if used offensively. And, so long as it is carried, it confers a +1 bonus to the holder's saving throw vs. all magical effects. This bonus is cumulative with other saving-throw bonuses, as per a *ring of protection*.

Experience Point Value: 1,000

Gold Piece Sale Value: 4,000

### *Rust Dust*

by Woodrow Smith

*Rust dust* looks like a fine metallic powder similar to *dust of appearance* or other magical dusts. It is usually contained in small silk pouches for dispersal by hand, or in hollow bone tubes for spreading by blowing through the tube. If it is shaken out by hand, one pouch will cover a 10' radius area; dust blown from a tube will create a 20' long cone, 1' wide at the start and 15' wide at the end. From 1-10 containers of either sort may be found at one time.

Any non-precious metallic materials within the area of effect of *rust dust* will rust (or otherwise deteriorate) and fall into useless scraps one round after being contacted by the *dust*. Precious metals (gold, platinum, and silver, for instance) are not affected. Objects of iron, copper, bronze, tin, and similar metals or alloys thereof — including mithral and adamantite — will be affected automatically if the item of which the metal is made is non-magical.

Magic items (swords, armor, shields, *rings of protection*, etc.) must save as if struck by a rust monster, gaining a 10% chance to withstand the *dust* for every "plus" of enchantment; thus, a +4 *sword* has a 40% chance of not corroding. Magical items or objects without a "plus" rating, such as an *iron flask*, iron golem, or *ring of spell storing*, have a 10% chance to save

# Super Heroes. Super Game. Super Figures.

The Number One super hero role-playing game— *Champions™* by Hero Games— now has official 25mm characters by the Number One miniatures company— Grenadier Models. The adventures are super. The 25mm villains and heroes are super. The play is super fun. For your free, illustrated catalogs, write to the addresses below. Or ask for Hero Games' *Champions™* and the figures by Grenadier Models at your local game or hobby store. Your secret identity will not be revealed.

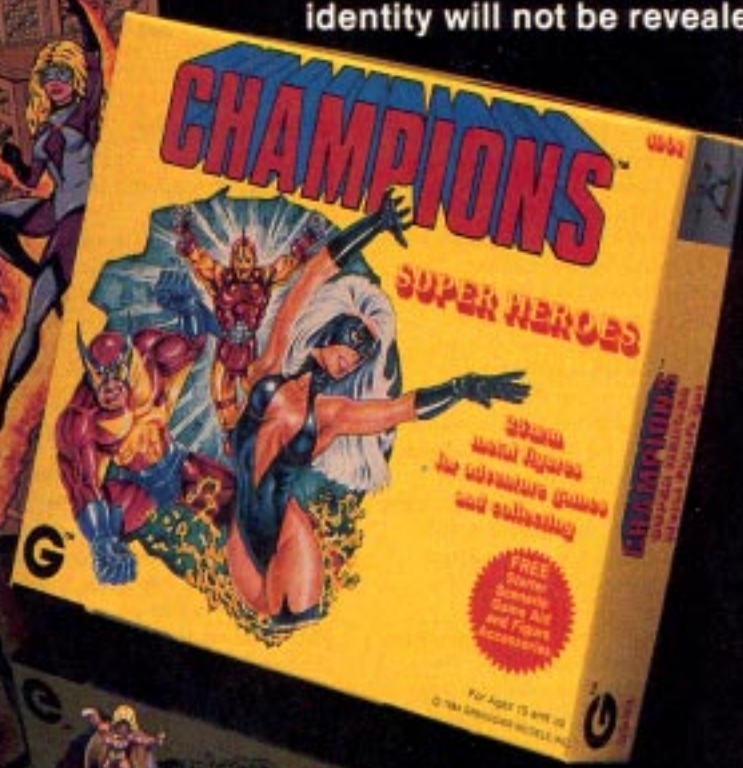
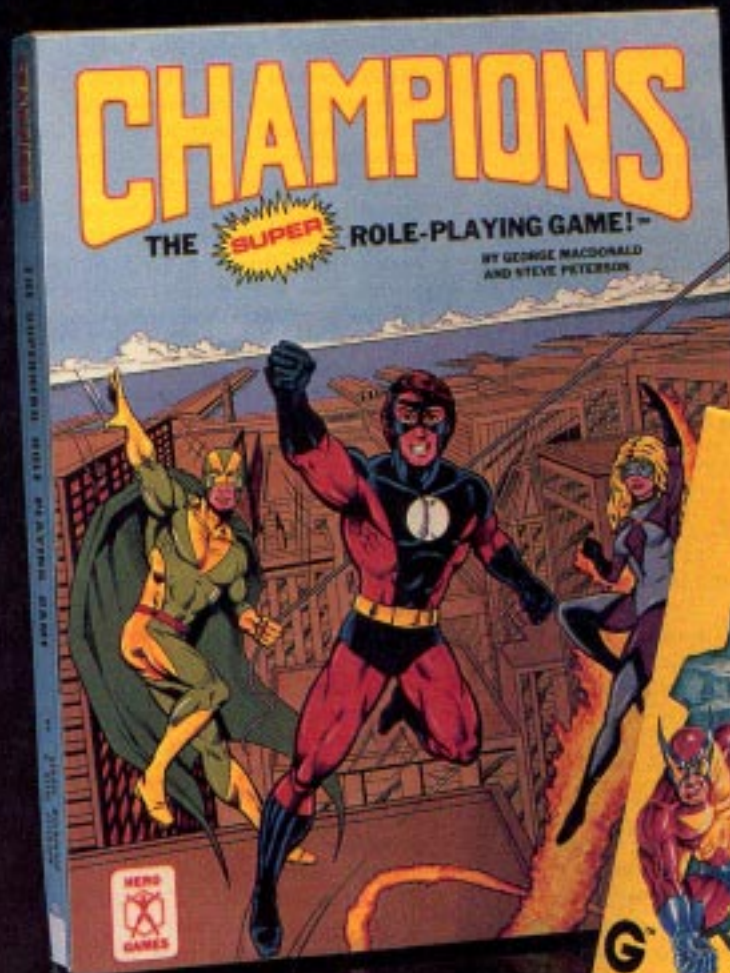

**Hero Games**  
92A 21st Avenue  
San Mateo, CA 94403

**Grenadier Models Inc.**  
Box 305, Springfield, PA 19064

CHAMPIONS is a trademark of Hero Games.



against the dust. All such saving throws must be re-rolled every time a new dose of rust dust is encountered.

Experience Point Value: 1,000  
Gold Piece Sale Value: 5,000

## Necklace of Alteration

by Jerome Mayard and Bill Birdsall

This mystical item appears to be a cheap necklace, like any other sort of magical necklace, until it is put on. It then turns into a chain of silver with twelve small globes of unidentifiable material suspended from it. Each globe appears identical to the others, but if a globe is pulled free of the necklace (which may be done in one round), the globe turns into a particular type of material and the wearer's body takes on the appearance and armor class of that substance. Though an *identify* spell, *wish*, or similar magical effect will reveal something of the nature of the necklace, no magic will be able to divine which globe of the necklace will have which effect.

Each of the twelve globes has a different effect. Once removed, a globe cannot be replaced on the necklace; its effects last for 2-8 turns and cannot be dispelled. Only after one globe's effect is ended can another globe be removed from the necklace. The necklace cannot be removed while its wearer is under the effect of one of the globes, except by the casting of remove curse or *wish*, in which case the entire necklace will vanish — but the effect currently taking place will still run its course. The necklace can be taken off, exchanged, and put on at will as long as one of the globes is not activated at the time. Anything being worn or carried by the user of the necklace that normally affects his armor class will be overridden by the effect of a globe for as long as that effect lasts.

When a globe is pulled from the necklace, the DM should roll d12 and consult the following table to determine the composition of the globe and the armor class bestowed on the wearer of the necklace, as well as the wearer's temporary skin and hair color. Re-roll to prevent duplicate results,

perhaps using a smaller die (d8, d6, etc.) when several of the globes become used up.

Die	Material & color	Armor class
1	Sandstone; light brown	8
2	Mithral; blue-silver	0
3	Gold; gold	6
4	Iron; dull grey	1
5	Platinum; silver	4
6	Granite; dull grey & red	3
7	Coal; dull black	9
8	Salt; dull white	10
9	Bronze; bronze	2
10	Adamantite; green-silver	-1
11	Lead; dark grey	5
12	Wood; brown	7

The necklace of alteration can be worn and used by a member of any character class or any humanoid of S or M size. Once used, the globes are generally worthless except as curios. The globes of gold, platinum, mithral, and adamantite have values of 1, 5, 20, and 50 gp respectively.

Experience Point Value: 1,000  
Gold Piece Sale Value: 5,000

## Dragonhelm

by Roger Raupp and Roger Moore

Dragonhelms were created for warriors who wished to have some of the special aura and powers of dragonkind. All such helms appear to be normal metallic helmets until worn; then they take on their true form of steel, with inlays of precious metals and gemstones. Some of these helms have dragonlike features or engravings upon them. All fighter types, clerics (but not druids), and bards are able to wear these helms.

When worn, a dragonhelm confers *infravision* on the wearer to a range of 60', and the wearer's senses are so heightened by the helm's powers that *invisible*, *etheral*, *astral*, *out-of-phase*, and hidden objects become detectable at a range of 10' per user's level (if multiclassed or dual-classed, the user's highest level as a fighter or cleric is considered).

The wearer may also radiate *fear* once per day at will. The aura will cause all beings (even allies) within 120' (12"

indoors or 4" outdoors) to save vs. spell, with wisdom bonus applicable, or flee from the wearer in terror for 3-12 rounds. This *fear* aura has no effect on beings with six or more hit dice/levels.

The helm counts as +3 armor against all head-directed attacks (such as those made by *vorpal* weapons), and saves as hard metal with a +3 bonus to the die roll. It does, however, have certain disadvantages. Because certain items like dragon scales and bone are incorporated into the helm's making and the helm draws power from them, certain elements of a dragon's personality will begin showing up in the wearer. After keeping it in continuous use for one month (putting it on every day, even if for only a moment), the wearer will begin to hoard money and valuables, refusing to part with the smallest copper piece unless absolutely necessary. The wearer will spend less and less on equipment, food, and clothing. Instead, the wearer will try to get other people to purchase such items, or may turn to theft and robbery if the character is neutral or evil. The wearer will also be less likely to respect or even listen to the opinions of others, will grow increasingly egotistical, and will tend to want to lead rather than follow. After the wearer uses this item continuously for two months or longer, he must make a saving throw vs. spells each time the dragonhelm is donned or become permanently afflicted with *megalomania*.

Another disadvantage is this: If the wearer comes within 120 yards of a true dragon (excluding wyverns and chimera, but including oriental dragons, faerie dragons, and the like), the wearer will find such a creature irresistible and will obey the dragon's commands as if *charmed*. This effect usually ends immediately if the helm is removed, but if the wearer has used the helm continuously for more than a month, the *charm* effect will last for 1-4 days even after the helm is removed. If the wearer has *megalomania*, the *charm* is permanent.

Dragons generally know all about dragonhelms, and sometimes leave them lying about in their treasure hoards for unwary adventurers to find and use.

Experience Point Value: 2,000  
Gold Piece Sale Value: 25,000



DENIZEN™

25mm FANTASY MINIATURES

LEGEND HAS IT THAT THERE WAS ONCE A MYSTICAL ARTISAN WHO WORKED ON AN ENCHANTED ISLE FAR ACROSS THE SEA. HE HAD THE POWER TO CAPTURE HIS SUBJECTS IN METAL LIKE NO OTHER. NOW YOU CAN BECOME PART OF THE LEGEND—THE LEGEND OF DENIZEN MINIATURES. YOU CAN ALMOST FEEL THE MAGIC...



PRESTIGE

HOBBY PRODUCTS, U.S.A.

488 Rustic Drive Wheeling, Illinois 60090

DENIZEN is a trademark of Prestige Hobby Products, USA and Denizen Miniatures, UK  
AVAILABLE AT BETTER HOBBY AND GAME SHOPS!  
In UK Only: Denizen Miniatures, 4A Powis Square, Brighton, Sussex BN1 3HH

## label your letter

The address of DRAGON® Magazine is P.O. Box 110, Lake Geneva WI 53147, and that's all you need to make sure your letter gets here. But you can help us serve you more quickly by adding a line at the top of the address to tell us what department should receive your letter or package. Call it a "manuscript submission," "cartoon submission," "query letter," or any other short phrase that tells us what's inside, and it'll get *exactly* where it's supposed to go.



# DO UNTO OTHERS before they do unto you!

Congress is controlled by the Mafia . . .  
South American Nazis are plotting the  
Final Reich . . .

And the Cattle Mutilators are trying to  
take over Hollywood!

## MORE SECRECY THAN EVER BEFORE!

△ Complete anonymity for back-  
stabbing, probing, infiltrating, and take-  
overs is now available **because you  
can now play ILLUMINATI by mail!**

△ Featuring new **ILLUMINATI** groups,  
new control groups, and an expanded  
method of controlling, neutralizing, or  
destroying other groups!

△ Probe groups you want to control,  
infiltrate them with your agents; then  
take control of their leaders – but  
beware, some of your trusted recruits  
may be infiltrators planted by other  
Illuminati!

△ Up to 32 actions per turn!

△ Operate in total secrecy or . . . make  
(and break) alliances.

**NO EXTRA \$\$ — No Beacon Fees —  
No Colonies — No Special Charges  
NOTHING EXTRA EVER!**

**PLUS:** No turn deadlines! 24-hour turn-  
around! Professional management!  
Extensive playtesting (over 1,000  
playtest turns already processed!)

### ILLUMINATI PLAY BY MAIL

**Setup Fee:** \$15.00 (Covers set-up, rulebook, and first 3 turns)

**Turn Fee:** \$4.00/turn after third turn

## BE THE FIRST ON YOUR BLOCK TO RULE THE WORLD!

**Adventure Systems, Dept. of Mayhem and Disorder  
1669-D South Voss, Suite FF, Houston, TX 77057**

ILLUMINATI and the all-seeing pyramid are trademarks of Steve Jackson Games.  
ILLUMINATI Play-By-Mail is a licensed version of SJ Games' ILLUMINATI boardgame. All rights  
reserved. Fnord.

# Presenting the Suel pantheon

## Adding to background for Greyhawk campaigns

by Lenard Lakofka

©1984 E. Gary Gygax. All rights reserved.

### EDITOR'S INTRODUCTION

In several installments beginning with this issue, DRAGON® Magazine will publish Len Lakofka's descriptions of the deities of the Suel pantheon — an expansion upon the material presented in the newly revised and updated WORLD OF GREYHAWK™ Fantasy Setting. The deities worshiped by the Suel peoples are as diverse and interesting as those chronicled in DRAGON issues #67-#71 under the heading "Deities & Demigods of The World of Greyhawk." Those personages were designed and described by E. Gary Gygax, author of the AD&D® game and

creator of the Greyhawk campaign, upon which the published WOG material is based. His descriptions are repeated in essentially the same form in the Glossography, one of the two bound volumes included in the boxed Greyhawk set.

The Guide (the other volume, intended for players' information) contains a listing of all the significant deities and demigods of the central Flanaess, but does not offer further detail on any except those that are also described in the companion volume.

It's not necessary but probably is advisable, to use this material in conjunction with the WORLD OF GREYHAWK Fantasy Setting. Everything a DM needs to incorporate these deities into a Greyhawk-based

campaign will be included here; or, the deities could be modified and perhaps re-named for use as the members of an individualized campaign's pantheon. But their intended use is as what they are: the gods — big and not so big, good and not so good — who by their existence shape the lives and the destinies of the Suloise peoples and others who worship them on the world of Oerth.

The list of Standard Divine Abilities given on the following page is reprinted as it appeared in issue #67 of DRAGON Magazine. These abilities apply to all Suel deities, just as they do to other deities of Oerth.

### LENDOR

#### Greater God

*The Prince of Time, Master of Tedium*

ARMOR CLASS: -8

MOVE: 15"

HIT POINTS: 320

NO. OF ATTACKS: 1

DAMAGE/ATTACK: 4-40 + 7, and  
see below

SPECIAL ATTACKS: Time magic, and  
see below

SPECIAL DEFENSES: Immune to  
banishment and similar attacks

MAGIC RESISTANCE: 95%

SIZE: M (6'2", 260 lbs.)

ALIGNMENT: Lawful neutral

WORSHIPERS' ALIGN: Lawful figures,  
also magic-users and astronomers

SYMBOL: Crescent moon crossing a full  
moon surrounded by 14 stars

PLANE: Nirvana

CLERIC/DRUID: 12th level cleric

FIGHTER: 13th level fighter

M-U/ILLUSIONIST: 19th level magic-user

THIEF/ASSASSIN: Nil

MONK/BARD: Nil

PSIONIC ABILITY: VI

Attack/Defense modes: None/None

S: 19 (+3,+7) I: 23 W: 21 D: 19

C: 19 Ch: 20

Lendor appears as a husky older man with white hair and a long white beard. He wears a large diamond ring (worth 500,000 gp) that will act as a *ring of protection* +5 for anyone he may lend it to. He can recall the ring at any time with 100% certainty.

Lendor's sword, named *Afterglow*, is a *flame tongue* sword with an ego of 18 and intelligence of 18. It is aligned for absolute



lawful neutrality, and no character or creature of a different alignment can wield it. It is +3 to hit vs. any kind of creature, and does 4-40 points of damage (plus Lendor's strength bonus) on every hit. It does full damage even to those creatures that are resistant or immune to fire. If it hits a chaotic figure in melee, that figure will take damage and must also make a saving throw vs. paralyzation at -3 or be paralyzed for 4-16 rounds. (The victim's magic resistance is applied prior to the saving throw,

but at a penalty of -20%; also, take into account Lendor's high level as a magic-user.)

Lendor can cast *time stop* three times per day, over and above any 9th level spells that he can cast as a magic-user. This spell will negate up to 45% magic resistance in another creature or deity, and then the figure obtains no ordinary saving throw. Ordinary mortals have no escape from the spell.

He is also able to *reverse time* for a temporal distance of up to one hour in any area

as large as a cube 100 feet on a side. All creatures in the confines of this cubic area must be present when time is reversed in order for them to be affected; someone who enters the area on the round after the power is invoked will see things as they "will be" after the *reverse time* effect wears off. If the power is used to bring life back to dead creatures, their remains must be present in the area of effect when the power is invoked. The figures inside the cube will have full knowledge of what has occurred (during the hour, or less, that they have to live over) and thus can act to prevent something that previously took place.

Lendor will use his *reverse time* power sparingly, usually only employing it to serve his personal purpose or on behalf of the most faithful of followers, and in any event he can only use the power once per day. Every time it is used, there is a 20% chance that the fabric of time inside the area of effect will be torn asunder. If this occurs, each creature in the area will be thrown backward in time from 10 to 1,000 years (roll separately for each figure affected).

In addition to a greater god's normal ability to *summon*, Lendor can call 3-6 spectators (see *Monster Manual II*), and the monsters will come within 4-16 segments. This power can be used up to three times per day. If anyone makes an attempt to call upon Lendor or *gate* him into their presence, he is certain to send at least one spectator before himself to determine the need, if any, for Lendor to materialize himself.

Lendor is the father-mother of the gods and goddesses of the Suel pantheon, and as such he may *banish* any the other deities back to his or her plane of existence for one month. This power can be used once a week. In addition, he can undo any *wish* or *limited wish* cast by another member of the pantheon, if that act is performed within 24 hours of the first casting. Lendor cannot be sent back to Nirvana by any of the other deities of this pantheon, nor do they have any effect on a *wish* spell that he may use.

He is able to *shapechange* at will, with his favorite forms being a huge silver dragon and a female elf.

Lendor's clergy are not common on Oerth. The few that are present are unswervingly lawful and seldom interact with others. His clerics' vestments are always silver, and the garment is adorned with a black circle containing Lendor's symbol.

Clerics of Lendor acquire certain special abilities, as follows: Upon reaching 7th level, they can perform long, tedious tasks in half the time it would normally take another person, and at this point in their advancement they become able to cast all their first-level spells in one segment less time than other clerics (except for *command*, which already has a 1 segment casting time). Upon reaching 11th level, clerics of Lendor can steadily perform any task without needing food or rest for twice as long as other characters, and gain the ability to cast their second-level spells one segment faster than normal (except for slow

## STANDARD DIVINE ABILITIES

All deities have the following abilities and powers in common, each usable at will:

<i>Astral &amp; ethereal travel</i>	<i>Know alignment</i>
<i>Comprehend languages</i>	<i>Levitate</i>
<i>Continual darkness</i>	<i>Mirror image</i>
<i>Continual light</i>	<i>Polymorph self</i>
<i>Cure (blindness, deafness, disease, feeblemind, insanity)</i>	<i>Read languages &amp; magic</i>
<i>Detect (charm, evil/good, illusion, invisibility, lie, magic, traps)</i>	<i>Teleport (no error)</i>
<i>Geas</i>	<i>Tongues</i>
<i>Infravision &amp; ultra vision</i>	

In addition, each group of deities has other particular powers and abilities, as described below. A number in parentheses after a listing indicates the times per day the power can be used; lack of a number means the power is usable as often as the deity desires.

### Greater Gods:

<i>Anti-magic shell (2)</i>	<i>Holy/unholy word (3)</i>	<i>Restoration (3)</i>
<i>Command, 4 rd. effect (2)</i>	<i>Improved invisibility</i>	<i>Resurrection</i>
<i>Control environment<sup>1</sup></i>	<i>Improved phantasmal force</i>	<i>Shapechange (3)</i>
<i>Cure critical wounds (3)</i>	<i>Polymorph any object (1)</i>	<i>Summon<sup>2</sup></i>
<i>Death spell (2)</i>	<i>Polymorph others (3)</i>	<i>Symbol (3)</i>
<i>Dispel (evil/good, illusion, magic (8 each)</i>	<i>Protection from evil/good, +3, 30' radius</i>	<i>Time stop (1)</i>
<i>Fly</i>		<i>Trap the soul</i>
<i>Gate (3)</i>	<i>Remove curse</i>	<i>True seeing (5)</i>
<i>Globe of invulnerability (1)</i>	<i>Remove fear</i>	<i>Vision (1)</i>
<i>Heal (3)</i>	<i>Regenerate</i>	<i>Wish</i>

### Lesser Gods:

<i>Anti-magic shell (2)</i>	<i>Holy/unholy word (2)</i>	<i>Remove curse</i>
<i>Command, 3 rd. effect (1)</i>	<i>Improved invisibility</i>	<i>Remove fear</i>
<i>Control temperature, 10' r.</i>	<i>Improved phantasmal force</i>	<i>Restoration</i>
<i>Cure serious wounds (3)</i>	<i>Minor globe of invulnerability (1)</i>	<i>Summon<sup>3</sup></i>
<i>Death spell (1)</i>	<i>Polymorph others (2)</i>	<i>Symbol (2)</i>
<i>Dispel (evil/good, illusion, magic) (4 each)</i>	<i>Protection from evil/good, +2, 20' radius</i>	<i>Trap the soul</i>
<i>Gate (2)</i>	<i>Quest (1)</i>	<i>True seeing (3)</i>
<i>Heal (2)</i>		<i>Wish (1)</i>

### Demigods:

<i>Anti-magic shell (1)</i>	<i>Heal</i>	<i>Raise dead (3)</i>
<i>Command, 2 rd. effect (1)</i>	<i>Holy/unholy word (1)</i>	<i>Remove curse (3)</i>
<i>Cure light wounds (3)</i>	<i>Invisibility</i>	<i>Remove fear</i>
<i>Dispel (evil/good, illusion, magic) (2 each)</i>	<i>Limited wish (1)</i>	<i>Summon<sup>4</sup></i>
<i>Finger of death</i>	<i>Phantasmal force</i>	<i>Symbol (1)</i>
<i>Gate (1)</i>	<i>Protection from evil/good, 10' radius</i>	<i>True seeing (2)</i>
		<i>Wall of force</i>

### Notes:

1 — *Control environment* subsumes both *control temperature* and *control weather*. It actually allows the greater god to adjust the surroundings of his or her immediate environment to suit his or her desire, even if the change is radical. The area of control extends from a 12" radius to a 72" radius depending on how radical the change required is.

2 — A greater god can *summon* from one to six creatures of the same alignment as the god, and all of the same type, with the total hit dice of the creatures so summoned not to exceed 40.

3 — The *summon* power of a lesser god can bring from one to three creatures of the same alignment as the lesser deity. Each must be of the same sort as the others summoned. No more than 25 total hit dice of creatures can be so called.

4 — For demigods, the *summon* power is limited to one or two creatures of not more than 20 total hit dice. Again, creatures must be of the same alignment and (if more than one is summoned) of the same type.

### Clerics' experience penalties

In many cases, clerics who worship a deity of the Suel pantheon are rewarded with certain special powers. As compensation for this privilege, a cleric must "pay" experience points, in the form of a penalty that forces the character to earn more points to advance in level than are required for a normal cleric. The recommended way to administer this penalty is to deduct the required percentage of experience points whenever experience points are awarded. For instance, a cleric who must pay a 10% penalty throughout his level progression will have 10% of his earned experience continuously deducted prior to the awarding of experience (usually at the end of an adventure). A cleric who must pay a penalty to advance to one particular level will do so after every adventure during the time he is rising through the next lower level.



poison, which already has a 1 segment casting time). Upon attaining 16th level, clerics of Lendor become immune to the effects of *time stop* spells that are cast by anyone except Lendor. These special abilities are "paid for" by special experience point requirements that all clerics of Lendor must meet. They must earn 5% more points than usual to reach 7th level (so that points are deducted throughout their time at 6th level); 5% more to attain 11th level (deducted while they are at 10th level); and 5% more to reach 16th level (deducted while they are at 15th level).

Temples to Lendor exist only in large cities, notably Lo Reltarma and Iron Gate.

## NOREBO

### Lesser God

#### *The God of Luck and Gambling*

ARMOR CLASS: -7

MOVE: 18"/36"

HIT POINTS: 145

NO. OF ATTACKS: 5

DAMAGE/ATTACK: 1-8 +5 (sling bullets), 5-8 +8 (dagger)

SPECIAL ATTACKS: See below

SPECIAL DEFENSES: See below

MAGIC RESISTANCE: 55%

SIZE: M (5'8", 175 lbs.)

ALIGNMENT: Chaotic neutral (evil tendencies)

WORSHIPERS' ALIGN: Thieves and assassins of any alignment; gamblers

SYMBOL: A pair of B-sided dice

PLANE: Pandemonium

CLERIC/DRUID: 3rd level in each

FIGHTER: Nil

M-U/ILLUSIONIST: 3rd level magic-user; also see below

THIEF/ASSASSIN: 25th level thief

MONK/BARD: 7th level monk

PSIONIC ABILITY: Nil

Attack/Defense modes: None/None

S: 20 (+4,+8) I: 19 W: 18 D: 25

C: 18 Ch: 11

Next to Kord, Norebo is likely the most popular god in the Suel pantheon. He appears as a man of average height, weight, and facial features. In any human form he, assumes, he can blend into a crowd easily. His tunic has the properties of a *displacer cloak*, when he wills it to act as such, and also serves as a *robe of eyes*. His boots allow him to *fly* at will.

Norebo can *polymorph* himself into any animal up to the size of a horse. He often chooses to assume the form of a mouse, a raven, or a cat so he can blend into his surroundings and escape rapidly if desired. In his humanoid form, he can alter his body proportions by as much as 20% and even change sex if it suits him. In this manner, he can assume the body structure and general appearance of any humanoid or demi-human larger than a gnome and smaller than an ogre.

He bears a sling that is +5 to hit and damage because of its magical properties.



He has a dagger that is +4 to hit and damage, and does an additional +8 to damage because of his strength. Norebo is so agile that he can attack five times per round with either of these weapons, or twice per round with each one if he chooses to change weapons during the round. He can use his sling five times per round even while flying. He can pick up any other sling and immediately cause it to become a +3 weapon to hit; that enchantment will remain with the weapon for as long as 24 hours after he puts it down, or it can be cancelled immediately.

Although Norebo generally only has 3rd level ability as a cleric, druid, and magic-user, he can cast three spells — *knock*, *dispel magic*, and *wizard lock* — at the 25th level of ability. A *wizard lock* cast by Norebo cannot be negated or removed by any method except physical breaking or by a successful casting of *dispel magic*.

Norebo enjoys visiting taverns and gambling houses in the guise of a cheerful, innocent stranger and setting up dice games against other patrons. He possesses a form of *telekinesis* that enables him to control the result of any roll of a single die, varying it by as much as +3 or -3 from what the result would have been — subject, of course, to the limits of the numbers on the die. (Imagine a die being thrown and almost coming to rest on a certain number, then making one or two more turns so that the final result is altered from what it otherwise would have been.) Norebo's skill with this power gives him a 95% success rate; when he fails, the die result will be the opposite of what he intended (-1 instead of +1, etc.). He will use this power to try to control die rolls whenever he gambles — but when he becomes intoxicated, his power goes sour and is only 50% accurate. The power is never good against more than one die at a time; if two or more dice are rolled at once, only one of them can be "fixed." It is impossible for a mortal to detect when this power is being used, just as it is impossible for someone to know Norebo's true identity unless the deity wills it.

Norebo is the patron of thieves and assassins. He does not care for overly lawful actions, but he believes in planning and is a staunch advocate of neutrality as opposed to good or evil. He is the lover of Wee Jas and is often in her company.

On very rare occasions, Norebo will utilize his ability to alter the dexterity of any mortal humanoid or demi-human. Such a change is permanent unless counteracted by some other form of magic or by Norebo himself. Norebo will almost never change a figure's dexterity by more than 1 point, and when he increases or decreases it by more than that amount, he will only allow the effect to last for a few days at best. He cannot lower a figure's dexterity below 3 or raise it more than 1 point above the normal racial maximum for that character. He will never reduce the dexterity of a thief or assassin below the minimum required for the class, as long as the character in question is one of his worshipers. Likewise, he will not lower the dexterity of one of his clerics below the minimum required for that character to remain as a follower — unless the cleric has committed a transgression that warrants his excommunication from Norebo's worship. It must be emphasized that he employs this power only very rarely.

Norebo enjoys minor magics, but he abhors multi-classed thieves and assassins who use spells to help harm or kill a target (for instance, casting *hold person*, then slitting the throat of the held victim). He finds such actions "unsporting" — and if he

AN SPI® BRAND STRATEGY-ADVENTURE GAME

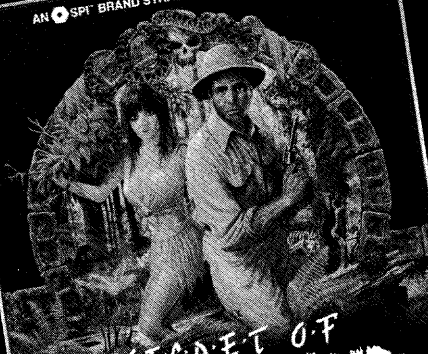

# SECRET OF SKULL ISLAND



AN SPI® BRAND STRATEGY-ADVENTURE GAME



# DRAGON'S DEN

A DUNGEONS & DRAGONS® ADVENTURE BOARDGAME



In this island adventure game, up to six players represent characters straight out of the 30s, trying to survive numerous perils as they search for the fantastic secret. Time is short as the volcano nears eruption. Can you escape in time? For ages 12 through adult.

In TSR's new adventure game, up to six players represent different characters and their abilities, creating a geomorphic dungeon, encountering various horrible monsters and gathering valuable treasure. Be wary of Aulicus, the dragon. For ages 12 through adult.

SPI,  
DRAGON'S DEN,  
SECRET OF  
SKULL ISLAND  
and TSR logo are  
trademarks of  
TSR, Inc.

becomes aware of a multi-classed follower doing such a thing, Norebo will do everything in his power to prevent that follower from ever again using spells.

Clerics who worship Norebo dress in brown or dark green robes. Churches and temples dedicated to his worship are often located on the outskirts of a town or city, or even further isolated out in the country. Norebo prefers natural settings for his places of worship, and services in his honor always involve drinking and gambling.

Norebo's clerics, including the occasional druid (10% likelihood that any cleric of Norebo will be a druid), must each have a dexterity of 9 or better. They must be either human, half-elfen, or half-orc, and the demi-humans can be multi-classed. All of Norebo's clergy are non-lawful, and none can be of neutral evil alignment. They all have the ability to *hide in shadows*, *move silently*, *climb walls*, and *remove traps* with the same success as a thief of equal level. As compensation for their special abilities, clerics of Norebo must earn an additional 10% in experience points to be able to advance from one level to the next.

In the world of Oerth, shrines to Norebo are known as Churches of the Big Gamble, and they abound in the barbarian states. There are known to be isolated churches on Lendore Isle (see AD&D® Module L1, *The Secret of Bone Hill*), along the Wild Coast, in Greyhawk and in various cities of the Iron League. □

## Index to advertisers

Name of firm or product	Page(s)	Name of firm or product	Page(s)
Adventure Systems.....	29	Hand Crafted Computer Products.....	20
AMAZING® Magazine.....	34	Hobby Game Distributors, Inc.....	77
Amulet.....	25	Indicia Associates.....	19
Armory, The.....	38, 39	Iron Crown Enterprises, Inc.....	1, back cover
Atlanticon.....	88	Mayfair Games Inc.....	13
Avalon Hill Game Co.....	7	Nova Game Designs, Inc.....	16
Bard Games.....	67	Origins '84.....	87
Companions, The.....	21	Pacesetter Ltd.....	57
Diamond Dice.....	13	Prestige Hobby Products.....	28
Dunken Co., The.....	11	Quest Games.....	84
Entertainment Concepts, Inc.....	85	RAFM Co., Inc.....	23
Fantasy Games Unlimited.....	11, 17	Ral Partha Enterprises, Inc. Inside front cover,	35
Game Designers' Workshop.....	82	Sleuth Publications, Ltd.....	19
Game Systems Inc.....	63	Strategists Club ballot.....	40
Gamelords Ltd.....	18	Stryke Enterprises.....	34
Gamers' Guide.....	90-91	Task Force Games.....	81
Games Workshop Ltd.....	15	TSR, Inc.....	33
GEN CON® Convention.....	68	Victory Games, Inc.....	5
Graaf Simulations.....	14	Wargames.....	89
Grenadier Models Inc.....	27	West End Games.....	Inside back cover

## We're More Than Simply



### A WHOLE NEW LOOK!

We're sparing no expense to bring you the best works from the finest science-fiction authors and artists! Our featured writers include Gene Wolfe, Poul Anderson, Robert Silverberg, Tanith Lee, and Ben Bova. Artists include Michael Whelan, Kelly Freas, and Steven Fabian.

### AN EXCITING EDITOR!

George Scithers, a four-time Hugo Award winner and former editor of Isaac Asimov's Science Fiction Magazine, is editor of AMAZING® Science Fiction Stories.



(Clip & Mail)

I'm convinced . . . send me my own personal subscription to AMAZING Magazine starting with the next available issue. (Please PRINT clearly)

Name \_\_\_\_\_

Address \_\_\_\_\_

City \_\_\_\_\_

State/Prov. \_\_\_\_\_ Postal Code \_\_\_\_\_

Country \_\_\_\_\_

#### Subscription rates for 6 bi-monthly issues (check one):

- In the U.S., \$9 per year
- In Canada, \$11 per year in Canadian dollars
- Foreign via Surface Mail, \$15 per year in U.S. dollars
- Foreign via Air Mail, \$30 per year in U.S. dollars

#### Check one to indicate your choice of payment:

- Personal check enclosed
- MasterCard
- Money order enclosed
- VISA

Credit Card No. \_\_\_\_\_

Expiration Date \_\_\_\_\_ M/C Bank No. \_\_\_\_\_

Signature \_\_\_\_\_ Date \_\_\_\_\_

Mail to: Dragon Publishing, P.O. Box 72089-AM, Chicago, IL 60609. AMAZING® Science Fiction Stories and FANTASTIC® Stories are trademarks owned by TSR, Inc. ©1984 TSR, Inc. All Rights Reserved.

"Pouches any merchant would be proud to bear, or cut purse to pilpher!"



Made of Genuine Leather.  
Our Pouches Come in 3 Styles:

- |                         |         |
|-------------------------|---------|
| A) 3 3/4" x 5" — \$3.75 | Colors: |
| B) 5" x 6" — \$7.25     | BLACK.  |
| C) 8" x 9" — \$9.75     | UMBER   |
|                         | WINE    |

Add \$1.75 Shipping & Handling

Send Money Order to:

**STRYKE** ENTRPR.  
P.O. Box 1486  
Lynn, MA 01901



# You've got the imagination. Now you need the Personalities.

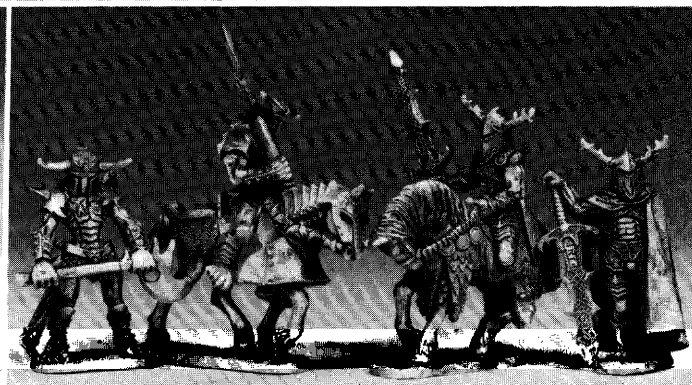
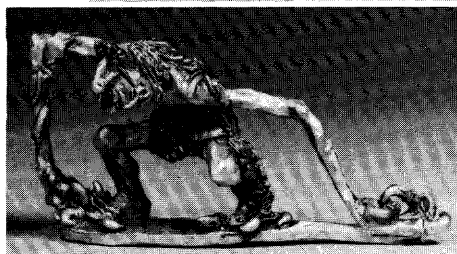
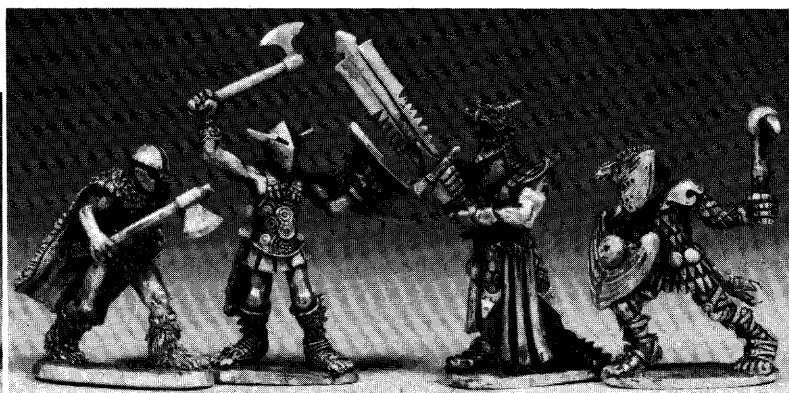

Shown clockwise from upper left: 01-122 Bandersnatch, 01-124 Warriors of Chaos, 01-126 Lord of Chaos (mounted and on foot), 01-125 Champion of Chaos (also shown mounted and on foot), 01-123 Well Drakken.

New figures from "Personalities and Things That Go Bump In The Night," sculpted in 25mm scale by Tom Meier. Featuring the long-awaited Bandersnatch and Jub Jub Bird, and a whole terrifying hierarchy of Chaos.

The ingredients your fantasies have been waiting for!

01-120	Cutthroats .....	4.50
*01-122	Bandersnatch and Jub Jub Bird .....	4.00
*01-123	Well Drakken .....	3.50
*01-124	Warriors of Chaos (4) .....	4.50
*01-125	Champion of Chaos, mounted and on foot .....	4.00
*01-126	Lord of Chaos, mounted and on foot .....	4.00

Some assembly may be required.

The fully-illustrated, 52-page 1984 Ral Partha Catalog and the 1984 Ral Partha poster are now available. Catalogs are \$2.00 postpaid; posters are \$2.00 + \$1.50 for postage and handling.

MONSTER STATS on the characters with asterisks (\*) are available and are free for the asking. Send a self-addressed, stamped envelope for an in-depth look at these intriguing creatures.



## RAL PARTHA ENTERPRISES, INC.

5938 Carthage Court • Cincinnati, Ohio 45212 • Toll Free 1 (800) 543-0272 • In Ohio (513) 631-7335 • For Mail Orders under \$30.00, Add \$1.50 Postage and Handling • Orders Over \$30.00 are Postpaid • C.O.D. Is An Additional \$1.50. • Available in Canada from RAFM Co., Inc. 19 Concession St. • Cambridge, Ontario N1R 2G6 • (519) 623-4832.

# Dragons and their deities

## The lowdown on how and why they worship

by Alan Zumwalt

Evil dragons worship Tiamat, and good dragons worship Bahamut. That is, for all practical purposes, the extent of common knowledge about the way dragons worship their deities. This article, a combination of deductive reasoning and logical assumptions, is an attempt to develop a system for dragon-worship that fits into the AD&D® game system and explains some things about dragon psychology and sociology at the same time.

For each type of dragon described in the Monster Manual, there is a small chance that any creature encountered will be a cleric. These dragons have access to cleric spells (in addition to their chance of possessing magic-user spell ability), and are more devoted than others in the homage they pay to their deity. All dragons respect and worship (in some way) either Tiamat or Bahamut, but for dragon clerics this devotion is more intense, and helps to dictate the way they conduct themselves in their lives. The chance for a dragon of a certain size and type to be a cleric is given in the accompanying chart, along with the maximum level a dragon cleric can attain depending on its age.

As might be expected, the methods of worship of the two dragon gods are similar in many respects. In each case, the deity's (un)holy symbol is in the shape of a miniature dragon claw, about the size of a human hand. Bahamut's holy symbol is ideally made of solid platinum (preferred) or some other metal plated with platinum. Often, a younger and relatively poor good dragon cleric will have a claw-symbol made of its own metal type. Tiamat's unholy symbol is an iron claw set with five gems (preferred) or crystals of red, blue, green, black, and white. A younger and poorer evil dragon cleric will have only one crystal (of its color) set in the center of the claw. A dragon cleric will wear or carry its holy symbol at all times outside or inside its lair; most often it is hung around its neck on a stout chain. One of the main goals of any dragon cleric is to acquire the most preferred type of holy symbol for itself.

The actual acquiring of the (un)holy symbol is a test that must be passed in order for a dragon to become a cleric. A dragon can attempt to become a cleric at any age, subject to the will of its deity, but more often than not, clerics are nurtured from birth. The danger of difficulty of obtaining a holy symbol varies according to the age of the would-be cleric; the task might be as

simple as persuading a dwarven metalworker to forge one, or as difficult as putting one's life on the line to perform a service for the deity. Either Tiamat or Bahamut may reward an aspiring cleric by simply bestowing a holy symbol upon the dragon, and they will also reward a cleric by upgrading its holy symbol to a more preferred type.

Its (un)holy symbol is usually the most valued and most fiercely guarded of all the items in a dragon cleric's treasure hoard. It is a symbol of the cleric's status among other dragons, and of the cleric's devotion to its deity. And it's necessary for a cleric to be in possession of its holy symbol in order to cast cleric spells (in effect, taking the place of material components). The losing of a holy symbol is considered near-blasphemy; a cleric's failure to recover a lost or stolen symbol is even worse than that — and if the cleric (for some unthinkable reason) doesn't even *try* to get it back, even at the risk of its life, its days as a cleric will be ended on the spot. If a dragon cleric's holy symbol is stolen, the cleric will hunt to the ends of the earth to find and kill the thief.

A dragon cleric makes a sacrifice to its deity once a year. Not surprisingly, the sacrifice is one of treasure — always a generous tithe (at least 10%-40%) of the treasure the dragon has acquired over the last year. If the cleric has lost treasure, or gained nothing new for its hoard in that time, the cleric will give up part of what it already had. During the ritual, the sacrifice will usually disappear, presumably going to the deity's home plane. If it doesn't disappear, that means there is something seriously wrong in the cleric's relationship with its deity, and some serious prayer, meditation, and treasure-grabbing is in order.

While Bahamut works with his clerics quite a bit, Tiamat cares little for dealing with her clerics. She delegates most of that work, and much of her authority in these tasks, to her consorts, only intervening if the communication involves a cleric of great power or advanced age.

As stated above, most dragon clerics are designated shortly after their birth. The parent of the newborn dragon must give a sacrifice (usually a valuable piece of treasure) to the nearest dragon cleric and ask the cleric to ask its deity to accept the newborn dragon as an apprentice cleric. If the deity thinks that the newborn dragon is the paramount of dragon perfection (or if it perceives a need to nurture a new cleric, for

whatever reason), the newborn dragon is tutored by the cleric for the first five years of its life, gaining the spell casting ability of a first-level cleric at age three if it is still an apprentice at that time. Both Bahamut and Tiamat are prejudiced against small dragons as clerics (but Bahamut is not as prejudiced as Tiamat). They are generally considered runts, not able to grow strong enough to be staunch and powerful clerics. The offspring of a dragon cleric is more likely to be accepted as an apprentice cleric than another dragon's offspring, mainly because of "tradition," parental preference, and the parent's knowledge (as a cleric) of what type of sacrifice pleases its deity the most. And since in this case the parent is also the tutor, the offspring of a dragon cleric usually turns out to be an above-average cleric itself.

A dragon cleric has the same chance for magic use as other dragons of its type; those who are (in effect) cleric/magic-users are not held in higher esteem than those who are "only" clerics. A dragon cleric has a 10% better chance than normal of being able to speak other languages besides its own, because many clerics receive language instruction as part of their apprenticeship training. And, because of their vigilance in the protection of their holy symbols, dragon clerics are only half as likely as non-clerics to be found sleeping in their lairs. (They do sleep, but a lot more lightly than other dragons.)

All dragon clerics have wisdom scores of at least 9. If desired, specific wisdom scores can be determined by using the figures on page 79 of the Dungeon Masters Guide, adjusting the minimum for each range so that it is not lower than 9. (For instance, a black dragon cleric, which has average intelligence, will have a wisdom of from 9-12, not the 3-12 range given in the book.) As with other clerics, dragon clerics with exceptionally high wisdom will be entitled to bonus spells.

Dragon clerics have no ability to summon, turn, or control undead beings. By their very nature, dragons are materialistic and egotistical, and they have little concern for human, demi-human, or humanoid spiritual matters, good or evil. Dragons prefer to avoid undead in all cases, unless the undead beings can be gotten rid of quickly and painlessly.

It is possible for dragon clerics to be granted assistance from the home planes of their deities, however. Good dragons may be sent the service of a couatl, while evil

ones may receive the help of an abishai devil of their own color. The chance for such service to be rendered equals the cleric's level expressed as a percentage, multiplied by 5. Aid of this sort can only be received once a year, and in payment a dragon cleric must immediately tithe half of its treasure to its deity — making clerics reluctant to resort to this plea for aid except in extreme circumstances.

Both dragon deities view their clerics as tools for combating and attempting to eliminate the great weaknesses of dragonkind — but each deity has a different impression of what those weaknesses are. To Bahamut and his retinue of good dragons, the weaknesses are the tendency of good dragons to perform questionable acts because of greed or subdual, and the existence of the evil dragons (which are somewhat more numerous than good dragons because of Tiamat's incredible ability to bear young) that give all of dragonkind a bad name. Tiamat sees the great weaknesses of dragons as the innate cowardice that allows them to be subdued into servitude, and the indefensibility of a dragon's treasure, which becomes harder to protect the larger it gets.

Both deities see subdual as a problem to be dealt with. Part of the training of every dragon cleric, good or evil, is an infusion of willpower that makes them more difficult to subdue than non-clerics. When the training takes hold (in 75% of all dragon clerics), a dragon cleric can only be subdued as if it was of the next highest age level. For instance, a young, huge blue dragon cleric (with 20 hp) is considered a sub-adult (with 30 "subdual points") on any attempt to subdue it. (An ancient dragon cleric is considered to have 9 "subdual points" per hit die.) And if a dragon cleric is subdued, it usually doesn't stay that way for long; the likelihood, of one remaining subdued cannot be defined as a strict percentage chance, but most clerics will be as difficult to keep subdued as any highly intelligent, spell-using dragon — and those with special resistance to subdual (as described above) will be even more resistant to continued servitude.

Subdual is considered a great disgrace for a dragon cleric, and depending on the circumstances will possibly require a great

sacrifice, loss of the cleric's "subdual point bonus" for 2-8 months +1 month per age level, or the partial or complete loss of cleric abilities, depending on the deeds done while subdued and the length of subdual.

In addition to their likelihood of being resistant to subdual, good dragon clerics as a rule are also especially resistant to bribery and manipulation. Among gold dragon clerics, 80% of them have this resistance (as described in the Monster Manual for all gold dragons). The proportion of silver dragon clerics that have this resistance is 60% (up from the 40% figure for non-cleric silver dragons), and 40% of all other good dragon clerics are similarly resistant to temptations that prey on their greed.

A dragon cleric performs several functions that are important either to its deity or to dragonkind in general, or both. A constant and all-encompassing function is to serve as a role model, representing "the ideal dragon" to all others of its kind. A dragon cleric is required to project an image of fearless power, lord over all it surveys, and to be steadfastly true to its alignment.

A second function is to be a messenger to its deity. Most dragon clerics have a "parish" which can range in size from one hundred to several thousand square miles, depending on the population density of a certain dragon type within an area. They have a responsibility to patrol this area thoroughly at least once a year, following up the patrol with a status report (transmitted by prayer or by spell) back to their deity or a minion of their deity, either to say that all is well or to reveal the existence of a threat of some sort. Many clerics of a chaotic or evil nature view this responsibility as a bother, since they derive no direct benefit from it themselves — but those who are lax in this duty and are found out usually live to regret their transgression. (And there is more turnover among the ranks of chaotic and evil clerics than among other dragon types, primarily for this reason.)

The third responsibility of a cleric is to serve as a messenger from its deity to the other dragons in its parish, delivering directives from Tiamat or Bahamut in the course of its patrol to all other dragons of the same type. Usually even a chaotic or evil

cleric will carry out this duty willingly, if its deity has made some pronouncement that needs to be spread throughout the populace. Such a directive often involves the demand of a sacrifice, and when a cleric receives a sacrifice it is usually allowed (in fact, expected) to keep part of the offering for itself before the deity takes the rest. Thus, these trips around the parish to "spread the word" are usually undertaken with vigor, because they turn out to be profitable for the cleric.

The spells given to dragon clerics are usually curative or divinatory in nature, rather than spells that cause damage; even evil dragon clerics operate under this stipulation. All dragons (and especially dragon clerics) are very egotistical about the amount of non-magical damage they can do with their jaws, their claws, and their breath weapon(s), and at the same time are painfully (literally) aware of the damage they can expect to suffer during their lives. So, a dragon cleric will tend to pray for and receive spells with which to protect itself (and its mate and offspring, if any) rather than spells, that would boost its own ability to do damage.

Note that the cleric levels given in the chart are maximums. Only about 25% of all dragon clerics of a certain age actually reach maximum level in that age group (not including those whose maximum level is 1). For instance, it is not uncommon to find an ancient gold dragon who is only a third-level cleric. This "underachievement" is primarily caused by the many times dragon clerics give in (or are forced to submit) to subdual, greed, and other behaviors that their deity finds offensive. The punishment for such offenses varies from type to type of dragon, and differs according to whether the offense was minor or premeditated. It can range from a higher requirement on the yearly treasure sacrifice, to a demand to perform some special service for the deity, to the loss of one or more levels of cleric ability. Repeated flagrant violators are stripped of all cleric abilities, if the dragon cleric worships Bahamut, or devoured by Tiamat or one of her emissaries, if the cleric worships the chromatic dragon.

Being a dragon cleric is probably one of the toughest jobs in the AD&D game universe. It has its rewards, to be sure — usually the sort of rewards that only a dragon can understand and fully appreciate — and this is why dragons continue to take up clerical apprenticeship, and why Bahamut and Tiamat can afford to be so choosy about which dragons they will accept as their representatives on this plane. Good dragon clerics must fight a constant battle against the instinctive greed and cowardice that they share with the others of their type. Evil dragon clerics don't have to worry quite as much about battling their instincts, because "bad deeds" are easier to justify when they're done in the name of evil, but they have to live in eternal fear of retribution from Tiamat for any "wrong" thing they might happen to do. II

## Dragon clerics for every color

Type	Chance of being cleric, by size				Maximum cleric level, by age						
	S	M/H	VY	Y	SA	YA	A	O	VO	Anc.	
Black	02%	05%	1	2	2	3	3	4	4	4	
Blue	02%	06%	1	2	3	4	5	5	6	6	
Brass	04%	06%	1	1	2	2	3	3	3	3	
Bronze	06%	08%	1	2	3	4	4	4	5	5	
Copper	06%	08%	1	2	3	3	3	4	4	4	
Gold	08%	10%	1	2	3	4	5	6	7	8	
Green	02%	07%	1	2	3	3	4	4	5	5	
Red	07%	10%	1	1	3	4	5	6	7	7	
Silver	05%	10%	1	2	3	4	5	6	6	7	
White	01%	03%	1	1	2	2	2	3	3	3	





# The Armory

MANUFACTURERS AND IMPORTERS OF DICE,  
DICE INKERS, DICE MARKERS, DICE POUCHES,  
PAINT, BRUSHES & GAMING ACCESSORIES

4145 Amos Avenue, Baltimore, Maryland 21215.

**NEW**

# The Armory's Super O's Super Opaque Acrylic Dice

New Longer Lasting Acrylic  
Available in 6 Vibrant Colors

**RED, IVORY, BLUE, YELLOW, GREEN, & BLACK**

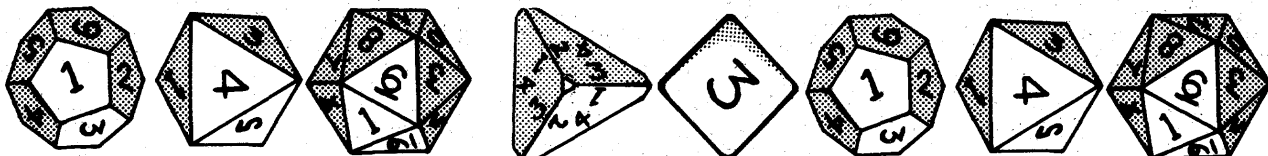

4,6,8,10,12,& 20 SIDED DICE AVAILABLE

## SPECIAL OFFER

Buy Any **6 Super O's** and get  
**1 Free Dice Pouch**

COUPON GOOD FOR 1 FREE DICE POUCH WITH  
THE PURCHASE OF 6 ARMORY POLY DICE  
**Clip This COUPON and Present  
it at Time of Dice Purchase to  
any of the Stores Listed on the  
Opposite Page.**

OFFER EXPIRES JULY 31st 1984

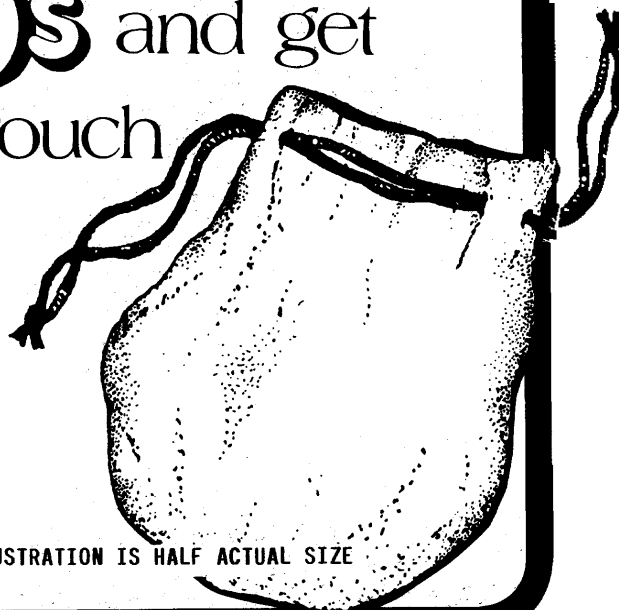

ILLUSTRATION IS HALF ACTUAL SIZE

# Armory *Super O's* & Free Dice Pouches Available From The Following Fine Hobby & Game Stores

<b>AL - HOMEWOOD</b> Homewood Toy & Hobby 2830 S. 18th St.(879-3986)	<b>FL - ORLANDO</b> Enterprise 1701 2814 Corrine Dr.(896-1701)	<b>MD - ROCKVILLE</b> Dream Wizard 84 Halpine Ct.(881-3530)	<b>NY - BUFFALO</b> Big Bob's Bike & Hobby 4254 N. Buffalo(562-3404)	<b>PA - MAYNE</b> Small World Hobbies 166 E. Lancaster(687-6875)
<b>AK - JUNEAU</b> Games People Play 2. Marine Way (586-4317)	<b>FL - TAMPA</b> Boardwalk & Park Place 3302 W. Buffalo Ave.(879-0653)	<b>MD - SYKESVILLE</b> Craft & Hobby Corner Carrollton Mall(795-0772)	<b>NY - MOUNT KISCO</b> Fox & Sutherland 15 S. Meyer Ave.(666-8088)	<b>PA - YORK</b> The Ordered Line 576 E. Market St.(846-3256)
<b>AR - JACKSONVILLE</b> Jack's Hobby Shop 2104 John Harden Dr.(982-6836)	<b>FL - TAMPA</b> The Fandom Zone 11124 N. 30th St.(977-1331)	<b>MD - WHEATON</b> Hobbies & Arts Wheaton Plaza S/C(949-3539)	<b>NY - NEW YORK</b> Compleat Strategist 320 W. 57th St.(582-1272)	<b>PA - SHIPPENVILLE</b> Bundy Wargame Shop Main St.(782-6226)
<b>AZ - PHOENIX</b> Hobby Bench Paradise Valley Mall(966-7200)	<b>GA - ATLANTA</b> Sword of The Phoenix Lenox Sq. Mall(231-4244)	<b>MI - EAST LANSING</b> Rider's Hobby Shop 920 Troubridge Rd.(332-6880)	<b>NY - SYRACUSE</b> Twilight Books and Games 1411 N. Salina St.(471-3139)	<b>PA - STROUDSBURG</b> The Encounter 515 Main St.(424-6132)
<b>AZ - SIERRA VISTA</b> Adventure Hobbies 624 E. Fry	<b>GA - AUGUSTA</b> Boardwalk & Park Place Augusta Mall(736-7664)	<b>MI - ROYAL OAK</b> Alcove Hobby Shop 2424 N. Woodward(545-6237)	<b>NY - STATEN ISLAND</b> Game World Staten Island Mall(494-2575)	<b>SC - CHARLESTON HEIGHTS</b> Swampfox Collectibles 3-B Northwoods Mall(797-2646)
<b>CA - FORT BRAGG</b> Dragon's Lair 219 N. McPherson St.(964-5070)	<b>IN - BLOOMINGTON</b> Hobby Shop 119 W. Kirkwood(339-5311)	<b>ME - CARIBOU</b> Memento's Model & Gift 86 Sweden St.(492-1581)	<b>NY - NEW YORK</b> Compleat Strategist 11 E. 33rd St. (685-3880)	<b>SC - NORTH CHARLESTON</b> Green Dragon 1015 Charleston Mall(744-8783)
<b>CA - LONG BEACH</b> Balboa Game Co. 530 E. Willow St(424-3180)	<b>IN - ELKHART</b> Adventurer's Quest 2005 Cassopolis (262-2121)	<b>ME - WATERVILLE</b> Hobby Shack 132 Main St.(822-1508)	<b>NY - HAMBURG</b> The Hobby Shop 15 Lake St.(648-7645)	<b>TX - ARLINGTON</b> Lone Star Comics & Sci-Fi 511 E. Abram(265-0491)
<b>CA - MERCED</b> Hobby Castle 60 W. Olive Ave.(723-6662)	<b>IN - ELMWOOD</b> Metalcraft Miniatures or More 1000 N. 9th St. (552-2073)	<b>MO - ST. CHARLES</b> Fantasy Shop 205 N. Main St.(723-5064)	<b>NY - UTICA</b> A & J Hobby House 20 Auburn Ave.(725-1015)	<b>TX - DALLAS</b> Armadillo Soldier Shop 222 N. Town Mall(241-8681)
<b>CA - PASADENA</b> The Gaming House 1260 E. Colorado Blvd(449-9107)	<b>IN - INDIANAPOLIS</b> The Game Preserve Glendale Galleria(257-9116)	<b>MO - INDEPENDENCE</b> Paladin Books & Hobby 10205 E. Turman Rd.(833-0613)	<b>NY - OSWEGO</b> Dons Dungeon 43 W. Bridge (342-4148)	<b>TX - DALLAS</b> Wargamer's World 10923 Indian Trail 102(241-2113)
<b>CA - SACRAMENTO</b> Dragon's Den 5819 Stockton Blvd.(452-6647)	<b>IA - DES MOINES</b> Fantasy Game Shop 2306 1/2 University(274-2521)	<b>MO - BONNE TERRE</b> Bonne Terre Hobby Shop 15 W. School St.(358-3521)	<b>NY - ITHACA</b> Quest's End 220 The Commons(272-5500)	<b>TX - EL PASO</b> Rita's Paperback Book Exch. 67 Sunrise S/C(757-1143)
<b>CA - SACRAMENTO</b> Gametowne 39540 Harney(291-1666)	<b>IA - MASON CITY</b> Oak Leaf Stamp & Comics 119 N. Commercial(424-0333)	<b>MO - COLUMBIA</b> Rockbottom Books & Comics 1019 E. Walnut(443-0113)	<b>OH - AKRON</b> Little Shop of War 5 Merriman Rd.(374-0814)	<b>TX - KILLEEN</b> Hobby Center 414 N. 8th St.(634-0488)
<b>CO - COLORADO SPRINGS</b> Miniature World Mall of The Bluffs (593-9900)	<b>IL - MT PROSPECT</b> Games Plus 20 W. Busse Ave.(577-9656)	<b>MO - OVERLAND</b> Games & Crafts 9220 Lackland Rd.(423-2199)	<b>OH - PATNESVILLE</b> Danielson's Dungeon 1480 Thatcher Dr. (357-5490)	<b>TX - LONGVIEW</b> Game Time 3500 McCann(253-5761)
<b>CT - DERBY</b> Space Traveller 116 Olivia St.(734-6400)	<b>IL - MAUKEGAN</b> Pegasus Hobbies 923 Greenwood(623-8333)	<b>MO - WEBSTER GROVE</b> Dragon's Lair 5 S. Old Orchard(968-3360)	<b>OH - MASSILLON</b> Wings, Wheels, Waves 1112 Andrew N.E.(833-0242)	<b>TX - MESQUITE</b> Lone Star Comics & Sci-Fi 144-6 Town East Mall(681-2040)
<b>CT - HAMPTON</b> Flock, Stock & Barrel U.S. Rt. 6 Box 1 (455-0272)	<b>KY - LOUISVILLE</b> Games Galore 3736 Frankfort Ave.(893-3228)	<b>MS - CORINTH</b> The Hobby Shop 1908 Shiloh Rd.(286-9733)	<b>OR - BEAVERTON</b> Tammie's Hobbies 3496 Cedar Hill Bd.(644-4535)	<b>VA - FAIRFAX</b> What's Your Game Fair Oaks Mall(591-7242)
<b>CT - NAUGATUCK</b> Witzend 92 Cherry St.(723-1619)	<b>KY - BOWLING GREEN</b> Asgard Hobbies & Games 1033 US 31 W. Byps(782-1398)	<b>MT - GREAT FALLS</b> Hobby World Holiday Village Mall(727-1010)	<b>PA - BROOMALL</b> Hobby City 30 Lawrence Pk. Ctr.(353-5131)	<b>VA - FALLS CHURCH</b> Strategy & Fantasy World 103 E. Broad St.(532-2477)
<b>CT - WEST HARTFORD</b> War & Pieces Inc. 7 S. Main St.(232-0608)	<b>KY - HOPKINSVILLE</b> Hobby Shop Pennyville Mall(886-5747)	<b>NC - BOONE</b> Reid's Toys & Hobbies Boone Mall(264-6323)	<b>PA - CLIFTON HEIGHTS</b> Town Bazaar 415 Bazaar Shop.Ctr.(623-9726)	<b>VA - HAMPTON</b> Campaign Headquarters 47 E. Queensway Mall(723-8433)
<b>DE - CLAYMONT</b> Book Thrift Tri-State Mall(798-3378)	<b>MA - BOSTON</b> Strategy & Fantasy World 201 Mass. Ave.(267-2451)	<b>NC - CHARLOTTE</b> The Dragon's Nest North Park Mall(596-9465)	<b>PA - KING OF PRUSSIA</b> Allied Hobbies King of Prussia Plaz(337-9737)	<b>VA - LEXINGTON</b> Crafts Plus Inc. 31 S. Main St. (463-3355)
<b>DE - NEWARK</b> Days of Knights 58 E. Main St.(366-0963)	<b>MA - NORTH ATTLEBORO</b> The Toy Depot 570 Kelly Blvd.(695-1672)	<b>NJ - BURLINGTON</b> Game World Burlington Center(386-6010)	<b>PA - KING OF PRUSSIA</b> Strategy & Fantasy World 254 W. Dekalb Pike(265-8562)	<b>VA - NORFOLK</b> White Heron Hobby Shop 1375 E. Little Cr. Rd.(583-5199)
<b>FL - BELLAIR BLUFFS</b> Modeler's Mart 760 N. Indian Rocks(585-4926)	<b>MA - WESTBORO</b> Hobbies, Games & Software Westboro S/C(366-2030)	<b>NJ - BOORHEES TOWNSHIP</b> Game World Echelon Mall(772-0880)	<b>PA - LANGHORNE</b> Levittown Hobbies Oxford Valley Mall(757-8086)	<b>VA - NORFOLK</b> Campaign Headquarters 145 E. Little Creek(583-9451)
<b>FL - DAVIE</b> Compleat Strategist 5406-8 Stirling Rd.(961-5660)	<b>MD - ANNAPOLIS</b> Ship Shop 75 Maryland Ave.(268-1141)	<b>NJ - MONTCLAIR</b> Compleat Strategist 215 Glenridge Ave.(744-6622)	<b>PA - LEMOYNE</b> The Magic Shop 829 J State St.(737-7559)	<b>VA - RICHMOND</b> One-Eyed Jacques 3104 W Cary St.(359-5163)
<b>FL - FERNANDINA BEACH</b> Gamekeeper 110 Centre St.(261-0535)	<b>MD - BALTIMORE</b> COMPLEAT STRATEGIST 201 Park Ave (752-1493)	<b>NJ - NORTH HALEDDON</b> Ultimate Encounters 1060 High Mt. Rd.(427-0383)	<b>PA - NEW CUMBERLAND</b> Kevin's Hobby Shop 311 Bridge St.(774-4404)	<b>VA - SPRINGFIELD</b> What's Your Game Springfield Mall(971-5951)
<b>FL - GAINESVILLE</b> Time Machine 2635 NW 13th St.(374-8593)	<b>MD - BALTIMORE</b> What's Your Game Harbor Place(685-0008)	<b>NJ - OLD BRIDGE</b> Adventure Hobbies 596 Englishtown Rd.(583-2088)	<b>PA - PHILADELPHIA</b> Game World Gallery At E Market(238-1339)	<b>VA - STERLING</b> Wargamer Hobby Shop 200 Leesburg Pike Rt.7(450-6738)
<b>FL - JACKSONVILLE</b> Boardwalk & Park Place 9911 Baymeadow Rd.(642-4303)	<b>MD - BALTIMORE</b> Worlds of Adventure 3715 Greenmount Ave.(889-6109)	<b>NJ - PRINCETON</b> Nassau Hobby 142 Nassau St.(924-2739)	<b>PA - PHILADELPHIA</b> Strategy & Fantasy World 2011 Walnut Rd.(563-2960)	<b>VA - VIRGINIA BEACH</b> White Heron Hobby Shop 1801 London Bridge(427-2223)
<b>FL - MIAMI</b> Hobbyland 17375 S. Dixie Hwy.(238-4387)	<b>MD - COLUMBIA</b> Patowmack Toy 1254 Columbia Mall(730-0977)	<b>NJ - WILLINGBORO</b> Willing Hobbies Beverly-Rancocas Rd.(871-9440)	<b>PA - PITTSBURGH</b> Bill & Walt's Hobby Shop 4801 McKnight Rd.(366-8686)	<b>MA - RAYMOND</b> Pacific Wholesale 147 S. 3rd St.(942-2433)
<b>FL - PANAMA CITY</b> Boardwalk & Park Place 2244 Cove Blvd.(785-5244)	<b>MD - OLNEY</b> Toy Traffic Olney Village Mart(774-2444)	<b>NJ - HOOVERIDGE</b> Game Room Hooveridge S/C(636-1111)	<b>PA - PITTSBURGH</b> Bill & Walt's Hobby Shop 116 Smithfield St.(281-9040)	<b>MA - RENTON</b> Heritage Book Shop Renton S/C(271-1776)
<b>FL - TALLAHASSEE</b> Boardwalk & Park Place Governor's Sq. Mall(878-5621)	<b>MD - WHEATON</b> Barbarian Book Shop 11254 Triangle Lane(946-4184)	<b>NV - RENO</b> High Sierra Models 953 W. Moana Ln.(825-9098)	<b>PA - READING</b> Trains & Things 1161 Perry St.(375-6051)	<b>MA - HARPER'S FERRY</b> Depot Hobby Shop 500 High St.(535-6610)

Retailers: If your shop is not listed and you wish it to be, please write The Armory, 4145 Amos Avenue, Baltimore MD 21215.

# Your Vote Counts in the 10th Annual Strategists Club Awards

For the tenth consecutive year, outstanding companies in the hobby gaming industry will be presented with Strategists Club Awards for the "Best New Product" of the year. We again need your help in determining which companies offered these "Best New Products" during 1983 in a number of categories.

Only new products released during 1983 are eligible for the 1984 Strategists Club Awards. New products do not include second or subsequent printings, or re-releases, of products available in 1982 or earlier.

You are invited to vote by mail for the most deserving product in each of the categories described below.

Winners of the awards will be announced at a Special Awards Ceremony on Thursday evening, August 16, 1984, at the GEN CON® Game Convention in Kenosha, Wisconsin.

To vote, simply complete the ballot at the right and mail it by August 1st to the address shown on the ballot. Vote for the products of your choice by printing the name of those products in the appropriate spaces provided on the ballot. If you know the name of the manufacturer of that product, indicate that as well. It is not necessary to vote for one product in every category, nor is it necessary that you attend the GEN CON 17 Game Convention to vote.

If you would rather not tear the ballot out of this publication, you may submit a photocopy of the ballot. Each person is allowed only one ballot, and only one voter's name may appear on each ballot. To be counted, each ballot must include the voter's name and address. Ballots not properly completed will be discarded. Awards will be given in the following categories:

## I. OUTSTANDING BOARD GAME

Any game designed to utilize a playing surface to regulate or record position or movement of playing pieces during play. Not included are games which have a playing surface but which use the surface only as a graphic device or visual aid.

## II. OUTSTANDING ROLE-PLAYING GAME

Any game requiring role-playing on the part of participants, and which does not require a playing surface as described under Category I.

## III. OUTSTANDING GAME, OPEN CATEGORY

Any game which does not qualify as a Board Game or Role Playing Game as defined above.

## IV. OUTSTANDING GAME PLAY-AID

Any product (excluding magazines, newsletters, and other periodicals) designed to assist, expand, or otherwise facilitate the playing of an existing game.

## V. OUTSTANDING MINIATURE FIGURE LINE

Any entire line of figures or major portion thereof that was released during 1983.

## VI. OUTSTANDING GAMING MAGAZINE

Any monthly or bi-monthly publication consisting of 16 or more pages per issue, having published 6 or more issues during 1983.

**OFFICIAL MAIL-IN STRATEGISTS CLUB AWARDS BALLOT**  
 Mail this ballot to: Strategists Club Awards, P.O. Box 110, Lake Geneva, WI 53147. To be counted, ballots must be postmarked by Aug. 1st. Please PRINT plainly the information requested.

Category I OUTSTANDING BOARD GAME

Product Name \_\_\_\_\_

Manufacturer \_\_\_\_\_

Category II OUTSTANDING ROLE-PLAYING GAME

Product Name \_\_\_\_\_

Manufacturer \_\_\_\_\_

Category III OUTSTANDING GAME, OPEN CATEGORY

Product Name \_\_\_\_\_

Manufacturer \_\_\_\_\_

Category IV OUTSTANDING GAME, PLAY-AID

Product Name \_\_\_\_\_

Manufacturer \_\_\_\_\_

Category V OUTSTANDING MINIATURE FIGURE LINE

Product Name \_\_\_\_\_

Manufacturer \_\_\_\_\_

Category VI OUTSTANDING GAMING MAGAZINE

Product Name \_\_\_\_\_

Publisher \_\_\_\_\_

(Be sure to complete the following.)

Name: \_\_\_\_\_

Address: \_\_\_\_\_

City: \_\_\_\_\_

State/Prov. \_\_\_\_\_ Postal Code \_\_\_\_\_

County: \_\_\_\_\_

BALLOTS MUST BE POSTMARKED BY AUGUST 1, 1984, TO BE COUNTED



# Great Stoney

## Build your own cardboard castle

### A grand tour

by Arthur Collins

The original name of this awesome structure was The High Keep of the Grand Chapter of the Order of St. Raphael. Since that was a little too elaborate for everyday use, the castle became known as Great Stoney. It is a fortified monastery, such as might be maintained by a band of ecclesiastical knights or an abbot who is also a temporal lord. While not a large castle in terms of area covered, it is quite tall and very well built, easily capable of housing a great number of folk of all degrees. The main chapel has a seating capacity of about 330, taking the balcony into consideration.

Great Stoney was designed to provide maximum security for its inhabitants without having to depend upon any natural defenses of the terrain. It is assumed that Great Stoney sits upon open meadowlands, surrounded by the fields that feed the monastic community. The surrounding area has no hills, cliffs, lakes, or other outstanding features to enhance the defendability of the castle. Therefore, it was built as concentric rings of stone, each part's defense easily supplemented by others, affording easy and rapid communication of forces within its perimeter.

*This view of Great Stoney shows the main gate in profile, with the drawbridge lowered to an almost-horizontal position. The tall rectangular structure in the center is the great hall and cloister.*

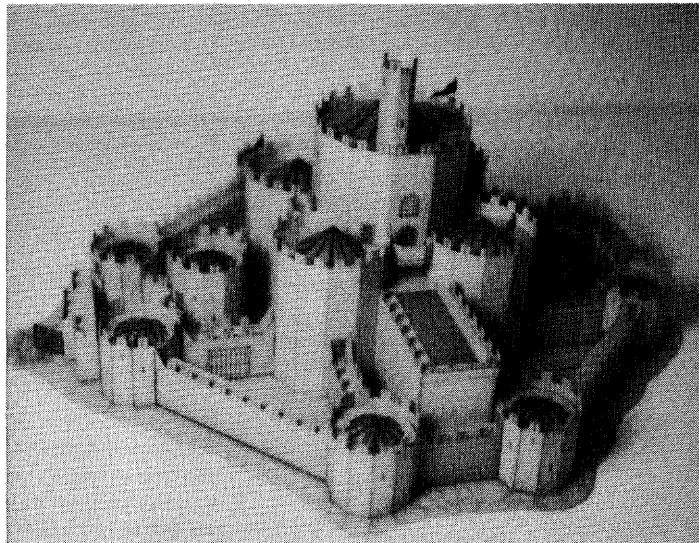

The great central tower rises eight stories (from the basement through the seventh story), with a watchtower going three stories higher. Supporting the central tower are four more towers, each five stories tall, grouped about the center in cloverleaf fashion. Giving further support to this huge volume of outward-pressing stone are eight two-story walls radiating out to the outer wall towers. Various other structures complete the complex.

**Outer defenses:** The outer walls of Great Stoney are very strong. They average about 10 feet in width, and rise two stories to the

height of the walk-wall, with crenellated battlements. The outer wall towers are three stories high, crowned with conical timber roofs. The main entry to the castle is through a barbican. A barred double door and portcullis form the outer gate, and between them is a small space covered by a murder hole above. If intruders breach the outer gate and get into the barbican, they can be fired upon from the outer gate wall and the three towers surrounding the entry area. Exit from the barbican into the central bailey is by way of two normal-sized doors between the three gate towers. A well-guarded postern gate is at the other end of the complex.

**Foundation level:** Supporting such a rockpile as Great Stoney requires massive foundations. Here in the bowels of the castle are the places where food and arms are stored, meat smoked, wine and ale made, and (yes, even here) criminals confined. In three of the towers, the foundation walls have been hollowed out to make extra storage hatches a few feet high.

Down here is also the crypt and its chapel, behind a wrought-iron gate. Corridors leading away from the crypt chapel traverse the foundation. Dead brothers are buried here by prying stones out of the floors and walls, then sealing up the bodies behind cenotaphs.

**Basement level:** Here on the main (first) level are the great public rooms of the complex — the kitchen, great hall, grand gallery, infirmary, sacristy, chapel, and chapter

*The castle as seen from the rear. The most prominent features in the foreground are the postern gate along the outer wall and the chapel with its sharply angled timber roof and stained-glass windows.*

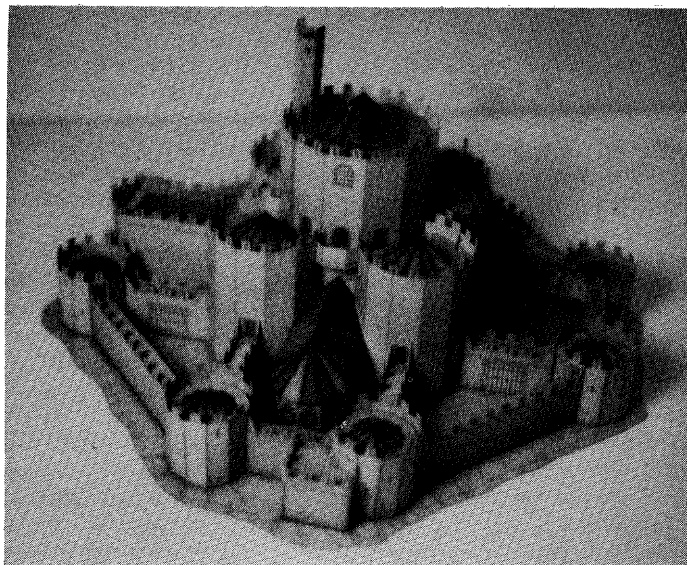

## Complete instructions and floor plans inside

house. There is also a lavabo, or bath area, where water from the cisterns can be run into a large pool for bathing. Garderobes (medieval toilets) and middens (cesspits) are everywhere throughout the complex. The middens have to be cleaned out every so often, and this is the single most obnoxious job of castle life.

The chapter house is a small chamber where senior members of the order gather for business meetings. The main chapel is the great worship area for the whole community. The altar has a hidden safe built into its back. Great windows are set into the exterior walls of the chapel. Font, pulpit, and chairs for the presiding officers are in the front. Seating is augmented by a balcony in the rear of the chamber.

Certain other conveniences are built into the complex, such as a dumbwaiter from the kitchen to the upper levels. Unlike many castles, this one has plenty of fireplaces. Altogether, it is a very comfortable place.

**First and second stories:** These tower rooms and the wing containing the great hall serve to house the cloister for junior brothers, the better living quarters, classrooms, guestrooms for hospitality (a medieval duty), a laboratory, and a library. The main business of the community is carried on in these areas.

**Third and fourth stories:** On these floors are the living and working quarters of the officers of the community, the treasury, the meditation chapel, and so forth. Large window seats set in the tower walls are found throughout. A great solar (sunroom) with balconies is a major feature,

**Upper levels:** The open areas around the edges of the conical roofs atop the cloverleaf towers are used for various purposes: a carpenter's shop, a greenhouse, a smithy,

*The closeup view at right shows the large central tower and two of the four towers that surround it. Atop flagpoles made from straight pins, pennants add a touch of color to the massive stone and wood structure. The detail photo below and to the right shows the draw-bridge, made more realistic-looking by attaching it to the gate with short pieces of small chain.*

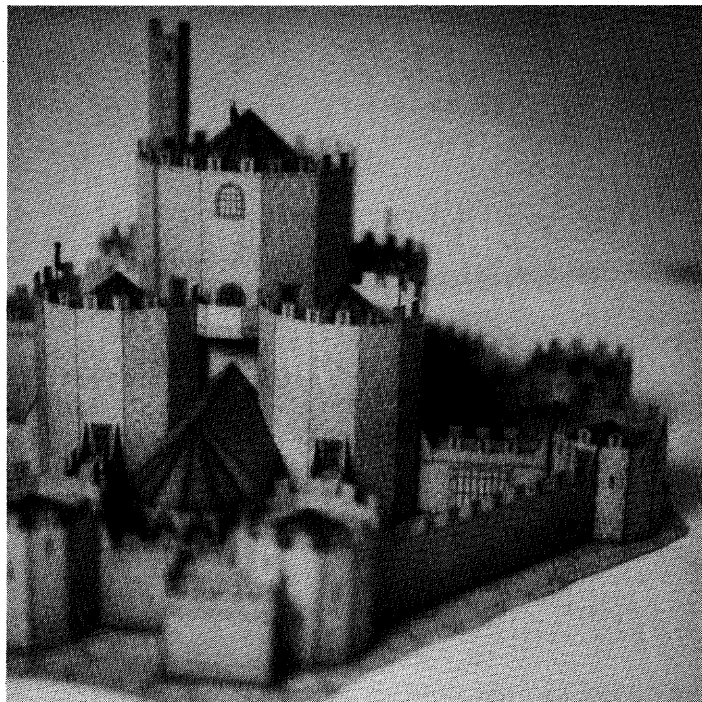

and an exercise area. The great central tower continues on up, giving further living and working space. On the very top of the central tower, beside its conical timber roof and close to the base of the watchtower, is a storage shed where astronomical equipment is kept.

**Conclusion:** It is perhaps no coincidence that Great Stoney resembles something like a beehive, for it is a tightly organized, packed community of very busy people. Well designed for defense, it nevertheless has many features for recreation and worship that one would not find in a secular lord's castle.

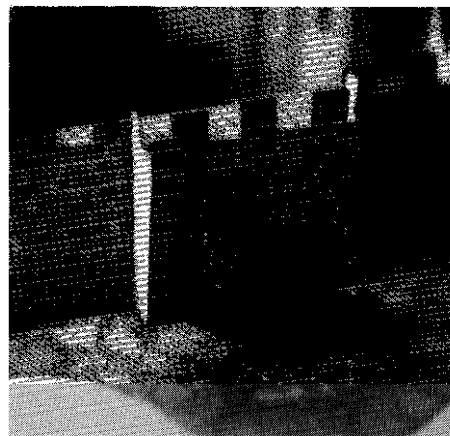

## *From concept to cardboard*

The cardboard version of Great Stoney that you can construct from the parts in this magazine is not identical to the castle that's depicted in the accompanying floor plans. Rather than being a disadvantage or a weakness, that fact is an indication of how the creation process differs depending on how many dimensions you're working in.

When Arthur Collins drew up his original floor plans for Great Stoney, he based the two-dimensional construction on his extensive knowledge of how a castle is laid out and built. When Arthur's floor plans were rendered in pen and ink for publication, we adhered to the design in that form.

But when Dennis Kauth turned Great Stoney into a cardboard sculpture, he deemed it necessary to change some design elements. Certain things that "work" in a drawing on graph paper weren't feasible or even possible to translate into parts that would fit together properly and could be squeezed onto four sheets of cardboard.

For instance, the walls of the cylindrical towers are thick in the drawings, but in cardboard they're only as thick as the cardboard itself. It would have been possible to construct thick-walled towers in cardboard by nesting one cylinder inside another, but that would have taken more space on the sheets than we had available — and it would have meant twice as many crenellations for you to cut out.

Arthur's design included flying buttresses that extended from the cloverleaf section down to the outer towers. In an actual stone construction, the buttresses would be essential to keep the massive center section from collapsing outward under its own weight. In cardboard, the parts would have been difficult to form and assemble; they would serve no structural purpose, since the center towers stand up quite well all by themselves; and again, there was the problem of space on the sheets. So . . . no flying buttresses (unless you make your own).

The roofs of the four cloverleaf towers were designed as flat surfaces, but Dennis supplied conical timber roofs for them similar to the ones on the outer towers and the center tower. One of the main reasons for this was aesthetic — "to give it a little color," in Dennis's words. If you want those towers to have flat timber roofs, leave off the timber cones and use markers or brown paper to color in the center of each roof section so that it looks like a flat timber surface instead.

Despite the minor differences between them, the floor plans and the cardboard structure can be used in conjunction with each other as a gaming aid, to help monitor the location of people and objects within the complex. In most cases where the floor plans and the sculpture are in conflict over a specific point, the floor plans should be considered the final authority — unless, of course, you have a reason for deciding in favor of the opposite viewpoint.

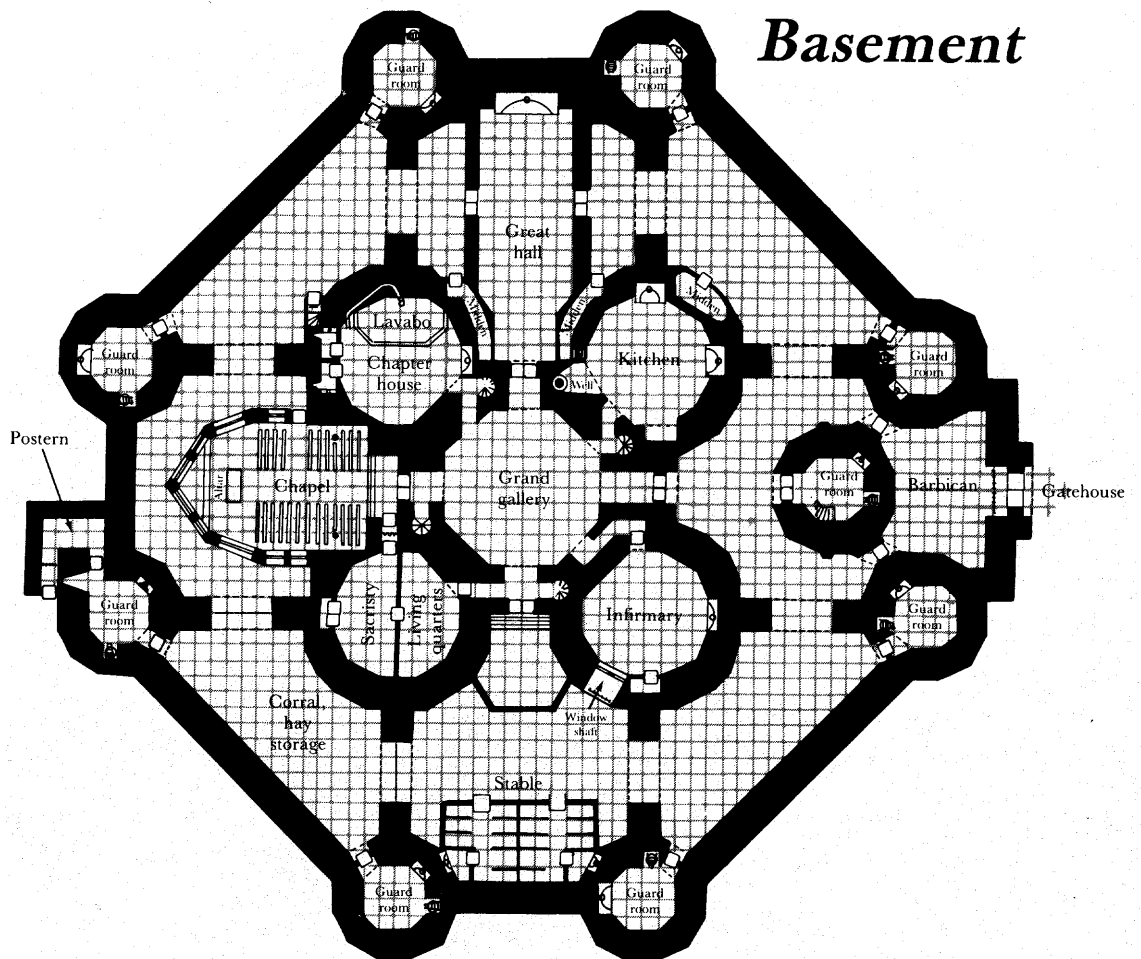
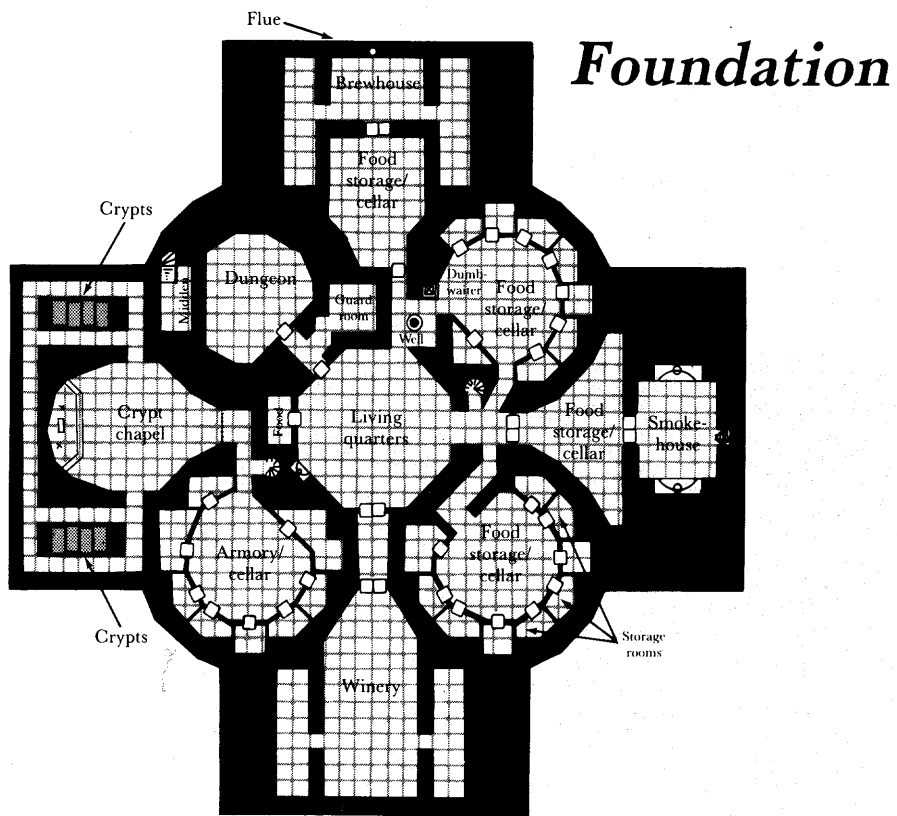



# How it all goes together

## I. THE BASICS

In addition to this copy of **DRAGON**® Magazine, you'll need:

- A 12-inch ruler or straightedge, preferably metal.
- A pair of sharp, pointed scissors, not too big (so you can wield them easily).
- A modeling knife with a sharp blade.
- A tube or bottle of high-quality glue for paper.
- A ball-point pen (one without ink is okay) or some other object to be used as a stylus for scoring along fold lines.
- Paper clips, spring-type clothespins, or similar items that can be used to hold parts together while the glue dries.
- A few straight pins.

1. Separate the two large sheets of cardboard from the center of the magazine. The best way to do this without damaging the paper is to pry up the ends of the staples, lift out the sheets, and then push the staples back down to hold the rest of the pages together.

2. Cut the pages apart into smaller sections for easier handling. Cut out the base first; this is the part that will hold all of the others, except for the small outbuildings (which have their own small bases).

3. Cut out the individual parts of the castle, one at a time as needed; notice that parts and groups of parts are numbered in the order of assembly. If you have a steady hand, you can use scissors for most of the long and straight edges. To cut out small detailed areas, such as the crenellations on the tops of the walls, a modeling knife and a straightedge to guide it are the best tools for true and accurate cuts.

4. Using the stylus and straightedge,

score each part along the black lines to make folding easier. (The black lines are only printed on the colored surface, but if you score the parts on that surface the colors might "break up." It's safest to do the scoring on the non-printed side, as long as you line up the straightedge carefully before scoring each line.)

5. Fold each part so that it forms the three-dimensional shape it's supposed to, then apply glue to the surfaces that will touch (only one surface, or both, depending on the kind of glue you use) so the part will stay in that shape. Refer to the schematic drawings to see how certain types of parts are constructed. If you're using a fast-setting glue, be sure the parts are aligned properly the first time you touch the connecting surfaces. If you're using a slow-setting glue, you may find it handy to clamp surfaces together with paper clips or clothespins until the glue dries.

6. Attach each part in its proper place, either on the base or on another part. Put down the center tower first, then the "cloverleaf" towers around it, then the great hall (location #3), then the chapel (#4) and so on, working your way toward the perimeter of the castle. Attach small parts as you go along to avoid being hemmed in later by other parts; for instance, put the doors on the great hall before gluing down the two walls that run parallel to the hall.

## SPECIAL INSTRUCTIONS

**Doors:** Many of the doors of Great Stony are designed to be shown in the opened position. Each of the open-door pieces is actually half of a door. As you cut each one out, fold it in half and glue it to make a piece that's colored on both sides

(see the diagram). Then, using a very small amount of glue, attach each half to the side of an open doorway. The door halves labeled 3 go at the base of the central tower and on the great hall. The door labeled 1 is for the doorway leading from the central tower to the roof of part #5. The doors labeled 9 go at the base of each of the outer wall towers.

**Outbuildings:** Because a castle often had such things in its vicinity (and because we had a little extra room on the cardboard sheets), we've provided three outbuildings, each in one piece, that can be folded and attached to their own small bases and then displayed outside the castle walls in any location you choose.

**Balconies:** The parts labeled B (on the sheet containing the base) are used to form the balconies that jut off the central tower along the tops of the cloverleaf towers. For added support and to be sure they're aligned properly, it's best to attach them after the cloverleaf towers are in place.

**Tower roofs:** Most of the flat roof sections that fit inside the cylindrical tower pieces should be fixed to the insides of the cylinders so that each roof is about 1/16 inch below the battlement. Exceptions are the roofs on the cloverleaf towers, which fit somewhat lower inside the cylinders so they'll be at the right height when the cloverleaf towers are fitted against and under the central tower. Whenever you're not sure how two pieces are supposed to fit together, try them on for size before applying any glue. The conical timber roof on each tower is designed to fit over the uncolored area in the center of the flat roof piece — there is no need to cut out the uncolored sections, and the structure will be weakened if you do

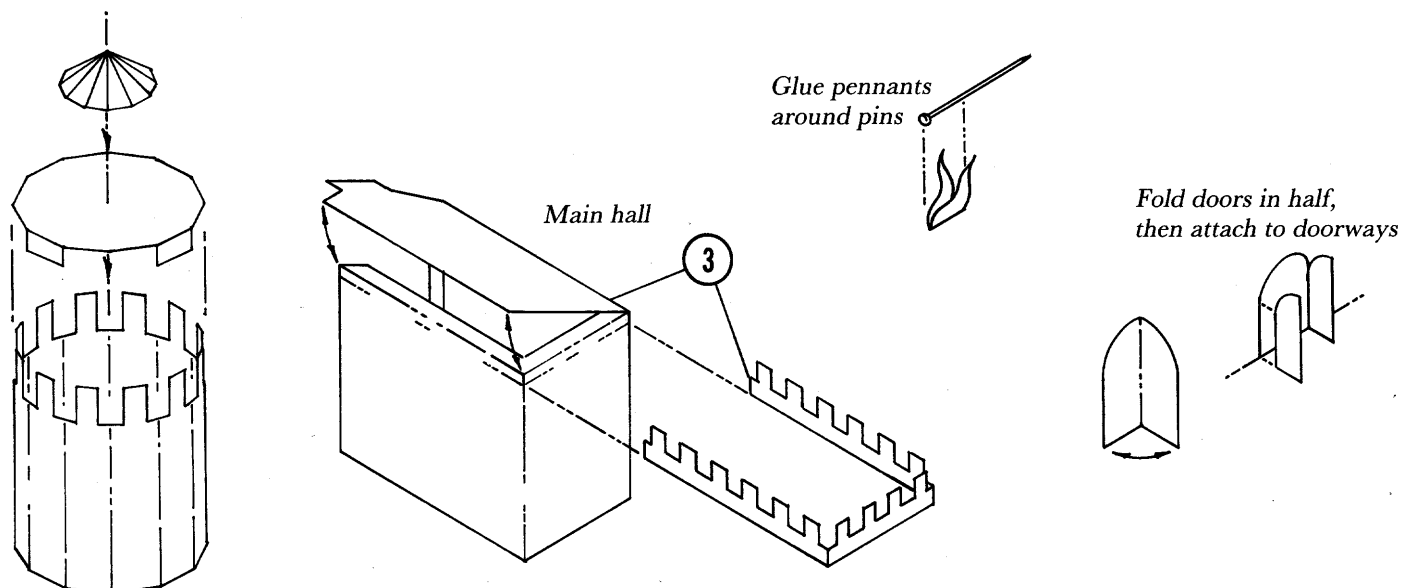

Typical three-piece tower



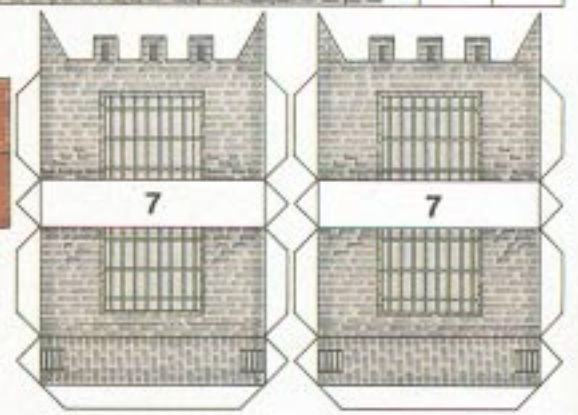
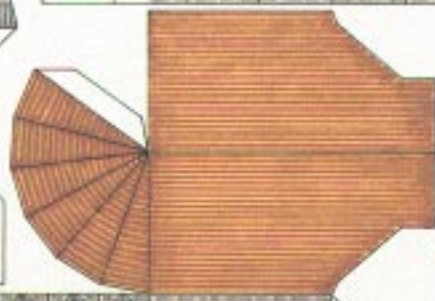
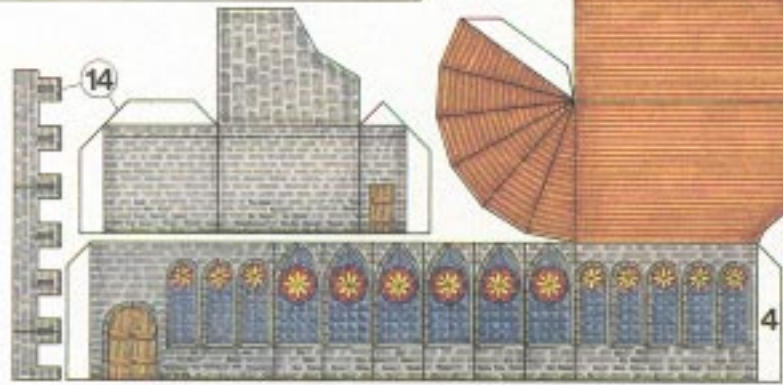
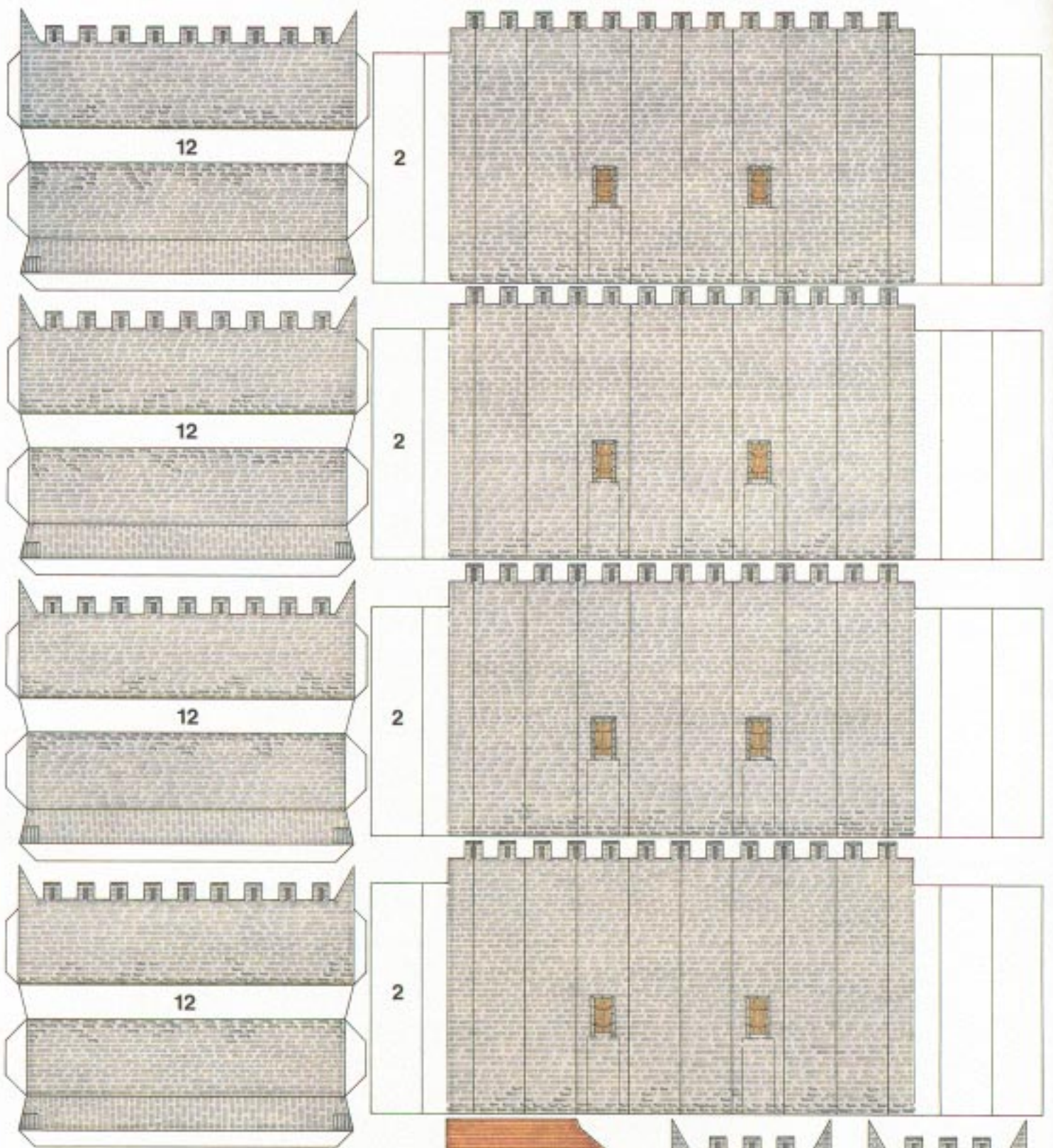





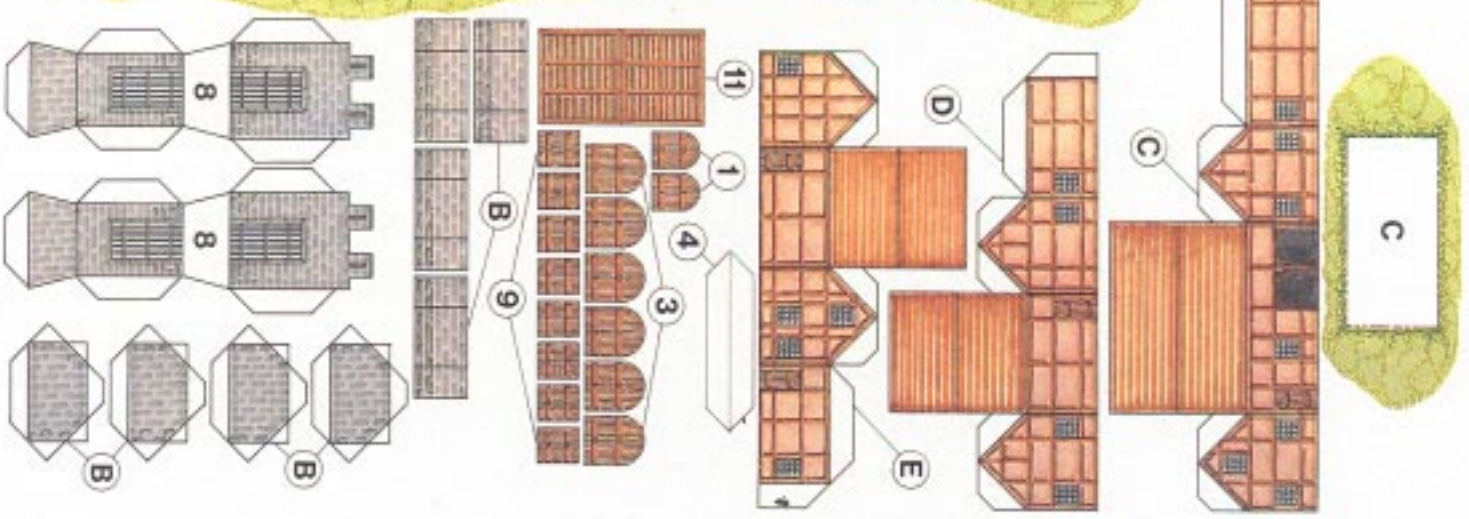
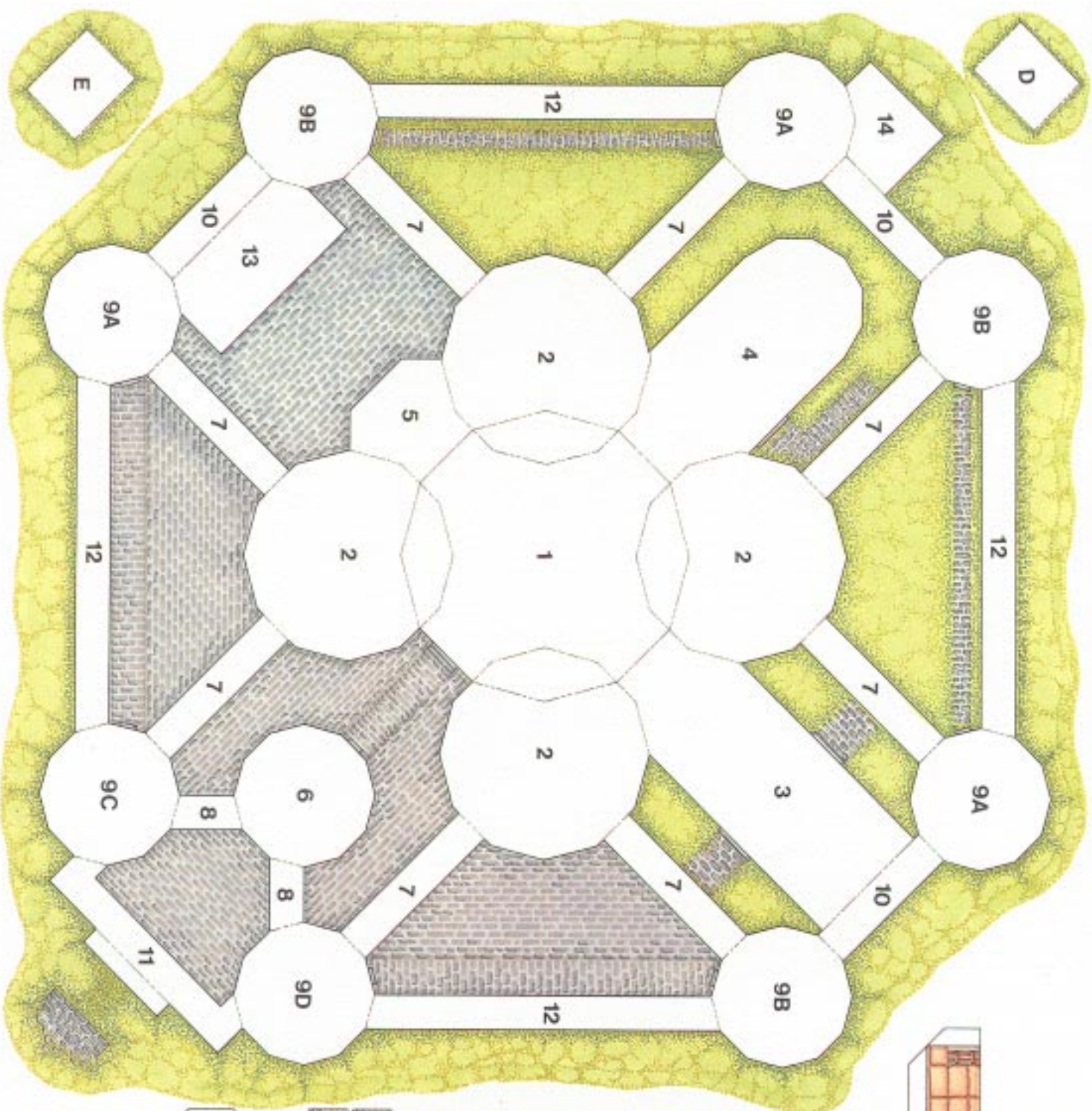



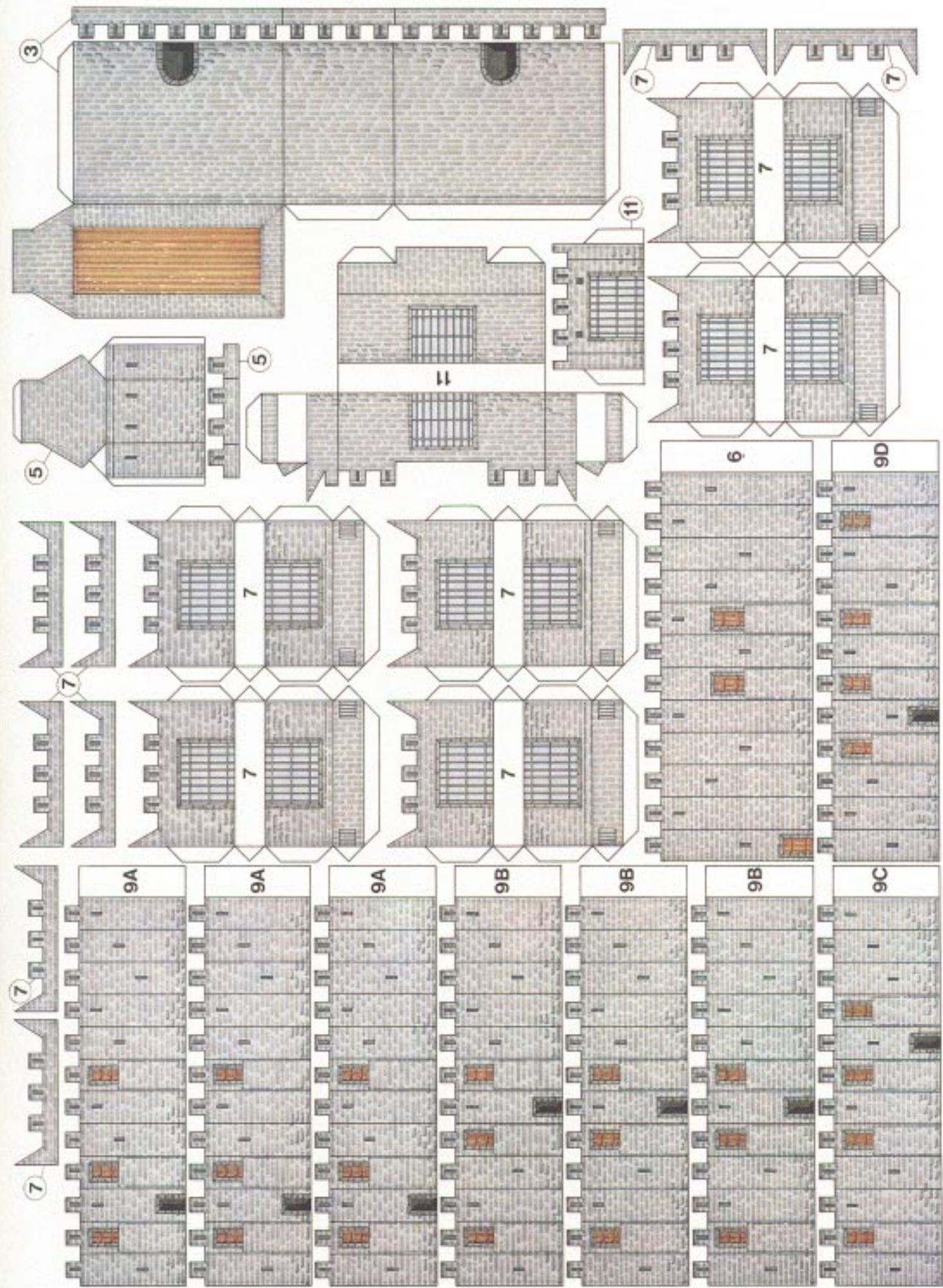





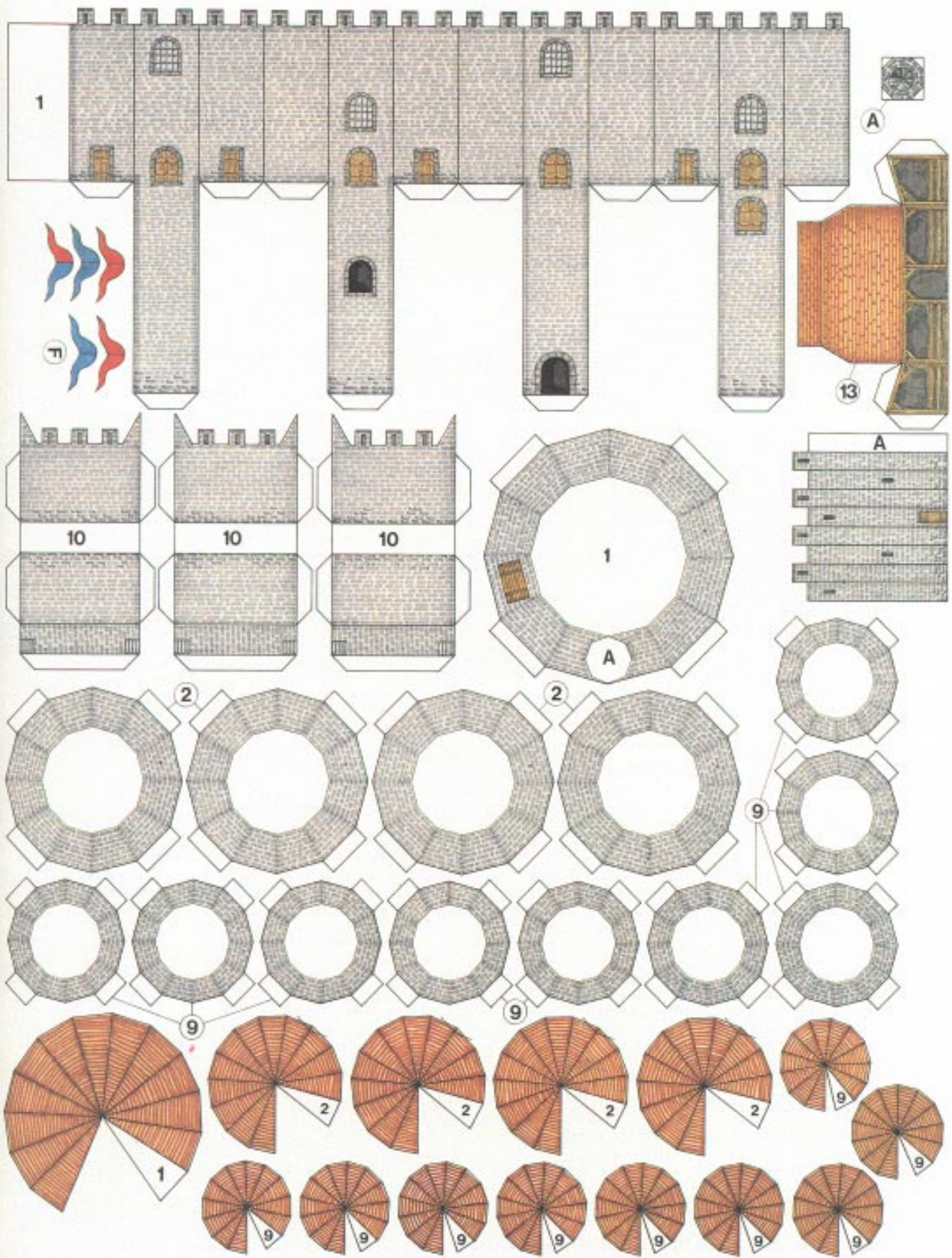





*Front gate construction*

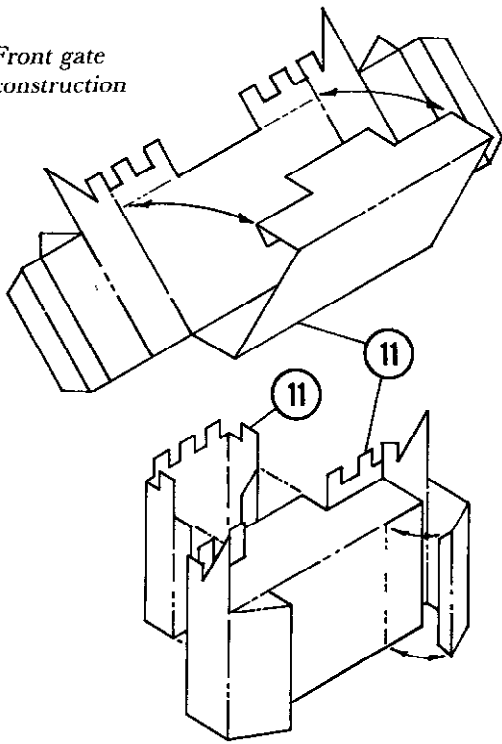

*Balconies  
(attach sides  
before final  
assembly)*

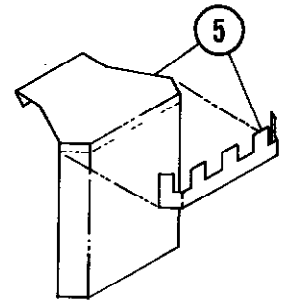

*Postern gate*

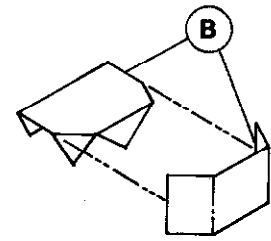
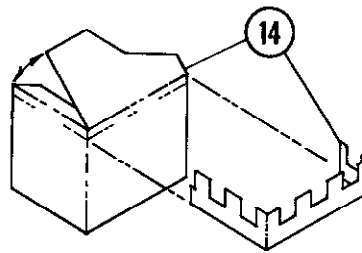

so. Each of the timber roofs on the clover-leaf towers is marked with a small notch that must be cut out to make the roof fit snugly against the central tower.

**ADVANCED TIPS**

Anyone who's experienced at scratch-building and detail work will think of several ways to make Great Stoney even more realistic-looking. Here are a few of the ideas we've thought of, including some things that were incorporated into the prototype model shown in the photographs.

With a couple of pieces of small chain and four straight pins, you can build the drawbridge (door part #11) in a partly

opened position, as in the prototype. Cut the chain to fit, then "bolt" it to the door and the wall with straight pins, clipping off the shaft of the pin with pliers or scissors. Wherever straight pins are used in the construction, try to get the type with colored heads that will match the color of the part the pin is used with.

The pennants fluttering from the higher towers are made by folding and gluing each paper pennant around a straight pin, then poking the pin through the black dot in each roof piece. To keep the pins at the proper heights, stick each one in the roof and fix it in place with a spot of glue before attaching the roof to the tower. For added realism and

a custom touch, design your own pennants, and try cutting them out of cloth — but first, seal the cloth with liquid glue to keep the edges from fraying.

By working very carefully, you can cut out any doors or windows you think should be opened; likewise for the portcullis gates along many of the walls. Simulate bars and latticework with thin wire attached to the inner surfaces of the wall or tower in question. As with many detailing projects, you should finish this work before proceeding with the construction of the part being detailed — for instance, it would be very tough to cut out the windows on the central tower after the central tower is attached to the base.

The stable area offers several opportunities for detailing. You can build hitching posts from toothpicks, and feed troughs from cardboard or balsa. Use flocking material or fibers of twine, or check out the spice and herb rack in the kitchen, for something that looks like straw.

Because the printed sheets are not colored on both sides, several uncolored areas will be visible on the finished product — particularly on the inside surfaces of walls and battlements. You can fix this by coloring those surfaces with a felt-tip marker in a shade of gray that will match the exterior. Markers will also be handy for covering up places on the exterior that get slightly damaged during construction.

As suggested in the section on the stable area above, you can build new parts and accessories for anything you consider appropriate. For instance, the roof of the central tower could use a three-dimensional storage

*This photograph offers a good view of the main gate area. Three towers ring the main entrance, making it very difficult for hostile visitors to penetrate further into the castle grounds.*

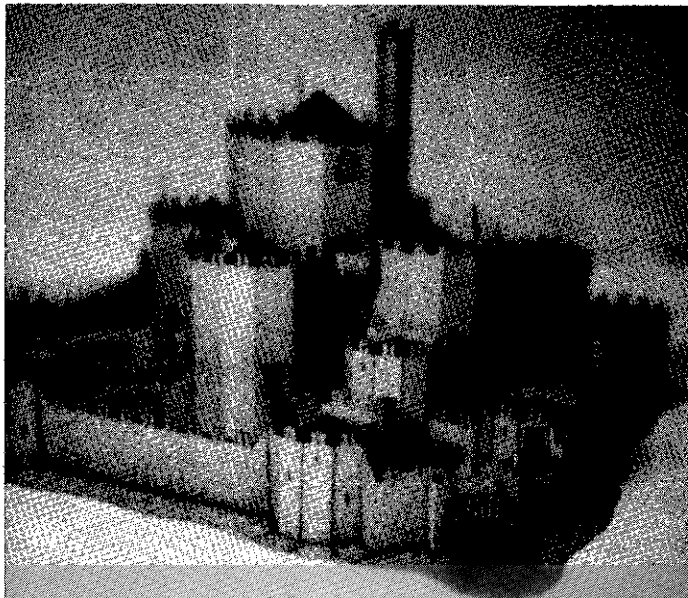

shed instead of the two-dimensional image shown on that surface. You could build sloping staircases from the walls to the tops of each of the outer towers. You may find good uses for small parts and bits of scenery from model railroad accessories.

It is possible, but not recommended, to go so far as to cut out the arrow slits on the crenellations along the walls. Even if you can do this with precision, the hole that's left behind will make a flimsy part even flimsier. With any extra cutting or detail work you attempt, be sure you aren't losing more than you're gaining because you've created a structural weakness in the process.

When you've got Great Stoney looking the way you want it, spray the entire construction with a dull coat finish to give the castle an appropriate flat luster, add some strength, and cover up any glue spots that may have found their way onto the exterior surfaces. When you're done, Great Stoney will be useful as a gaming accessory (if anyone in your campaign is lucky enough to encounter — or own — such a grand place) or a display piece, either as the focal point of a diorama or sitting on a shelf all by itself.

*Anyone with a fear of heights was probably not required to work a shift in the lookout tower, which extends three stories higher than the roof of the central tower and a dizzying 165 feet (at 15 feet per story) above ground level.*

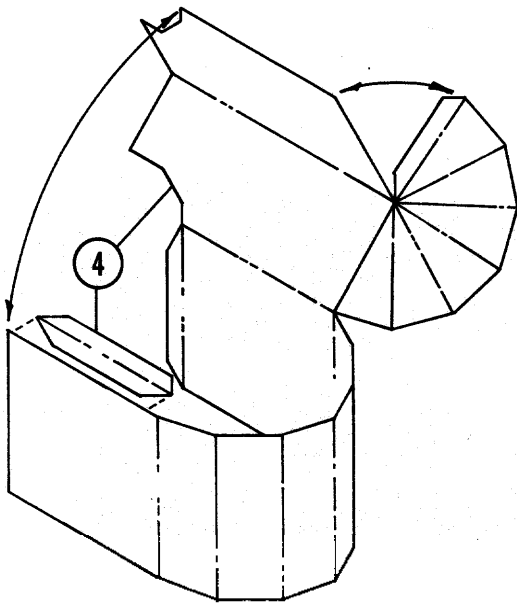

*Chapel construction; note piece that attaches to wall and roof*

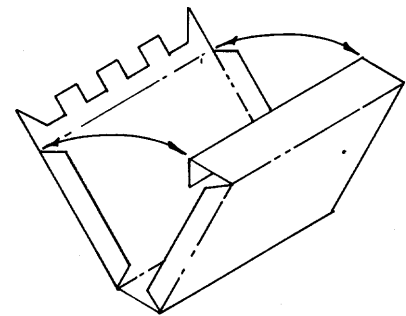

*Typical wall piece; glue sides first, then top*

### **Where credit is due**

Original design and floor plans: Arthur Collins

3-D design and instructional drawings: Dennis Kauth

Graphic rendering: Roger Raupp

Everything Arthur didn't write: Kim Mohan

*1st story*

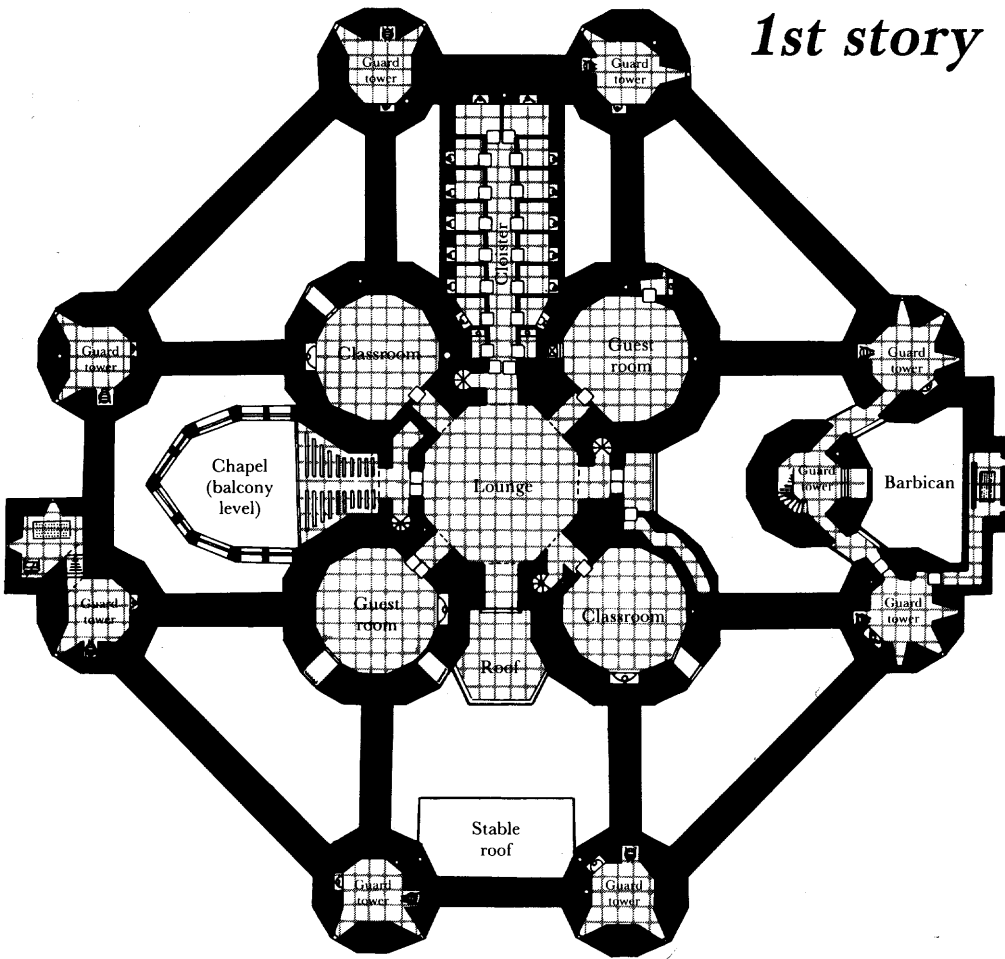

*2nd story*

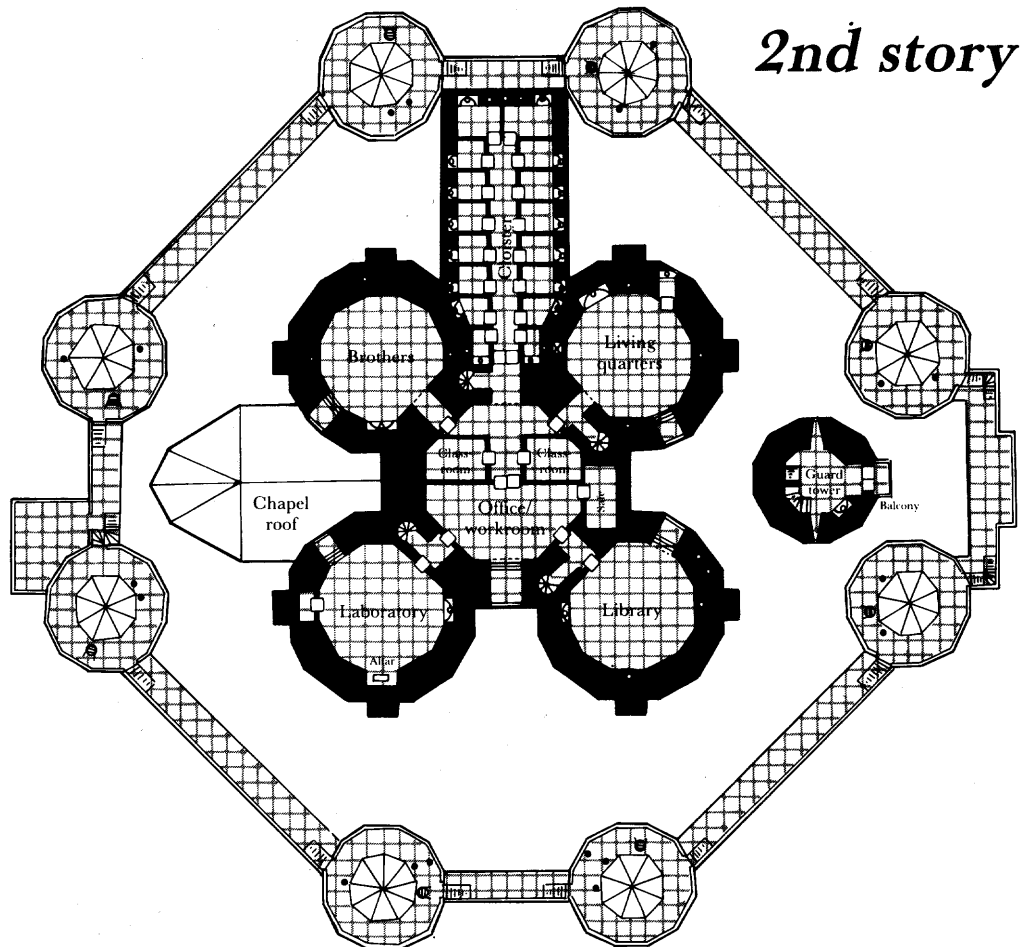



*3rd story*

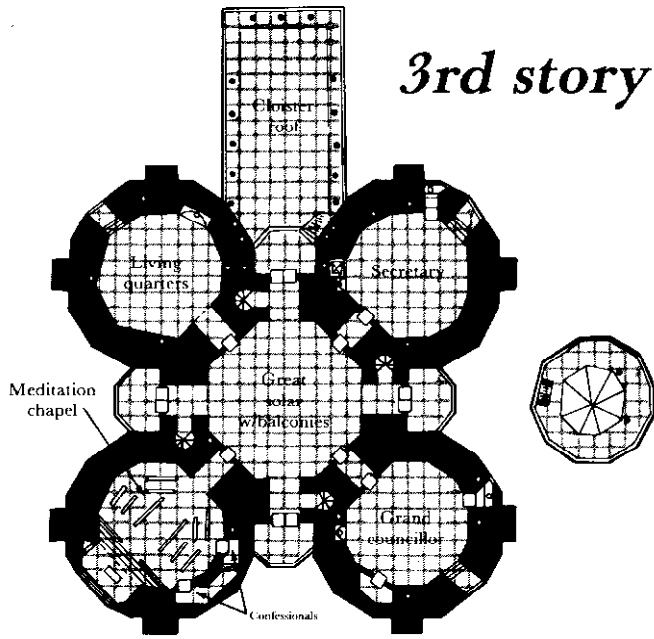

*4th story*

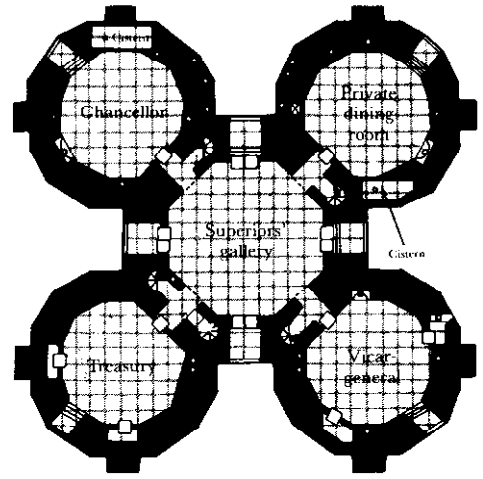

*5th story*

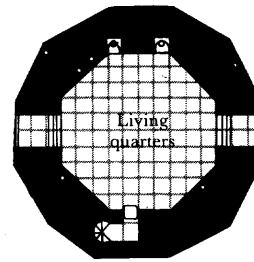
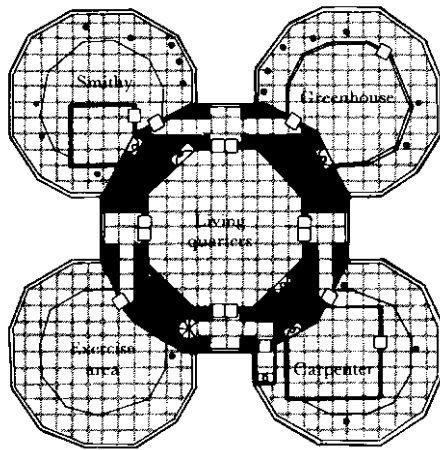

*6th story*



*9th story*

(Stairs to top)

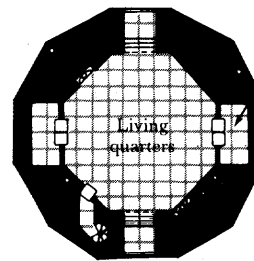

*7th story*



*10th story*

Lookout tower

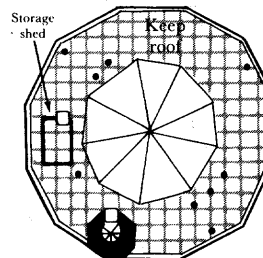

*8th story*

Scale: 1 square = 5 feet

# DON'T TURN OUT THE LIGHTS.

# CHILL™ IS COMING!



"CHILL": Adventures into the Unknown" is PACESETTER's spine-tingling role-playing game of horror and suspense. This complete role-playing system allows you to set adventures in any time period, with special emphasis placed on Gothic horror and contemporary thriller scenarios. The game is specially designed to allow

play within 30 minutes of opening the box, providing whole new dimensions of role-playing. Included in the game are an 8-page basic rules folder, a 16-page adventure, a 32-page manual of creatures, a 64-page campaign rule book, a large color map, three dice, and 140 color counters.

## TERROR WAS NEVER THIS MUCH FUN

**Pacesetter**

All trademarks owned by Pacesetter Limited - P.O. Box 451, Delavan, WI 53115 - ©1984 All Rights Reserved.







#### HAVEN HEADS REFLECTING

the morning light of Jua the sun, red-brown bodies swaying like reeds dancing in a gentle wind, the women of the Ilyassai formed a wide circle in the yellow grass of the Tamburure. Within the circle, two

*ngombe* cows lay in the posture that signalled the imminence of their calving. One of the *ngombes* lay quietly, only the rhythmic bunching and relaxing of her flanks betraying the effort of birth. The other tossed her long-horned head and groaned in pain. Spasmodically, her hoofs kicked clumps of grass from the Tamburure.

The women exchanged troubled glances.

"Sifa will have a difficult calving," said one. "She may die."

"We must sing," said another.

A soft, sweet chant rose from the throats of these Ilyassai women. It was the song that welcomed new life to the Tamburure. It was the same song that would have heralded the birth of a human child, for among the Ilyassai, *ngombe*, woman, and man were all one within the tribe.

Not far from the singing women, a group of boys clustered with barely concealed impatience. Most of them were six and seven rains of age, still neophytes in *mafundishu-ya-muran*, the rigorous warrior-training that molded Ilyassai youths into men fit to be masters of the Tamburure. With almost painful anticipation, the boys awaited the double calving. None of them had yet been given a *ngombe* to tend. Before this morning ended, two of them would receive their first calf. And they would begin their journey on the herdsman's path all Ilyassai followed.

One boy sat apart from the others. He was older than they were. At ten rains' passing, he was a sullen-eyed, dark-skinned changeling of a boy, hard muscles already swelling on his sturdy frame. His name was Imaro, and he was the only boy his age who did not yet have at least one *ngombe*.

"I don't see why *he* even came here," one of the younger boys said loudly. "He'll never have a *ngombe*."

The boys laughed. Imaro refused to look at them, even when the wind carried the familiar taunt "son-of-no-father" toward his ears. These words were as true as they were familiar. Nine rains ago, his mother had brought him to the *manyattas*, the oblong leather dwellings of the Ilyassai. She was Ilyassai, but the father of her child was not; and she refused to name him, thus violating one of the most inflexible of Ilyassai taboos. Only her aid in ridding her people of a sorcerer who had sought to corrupt and enslave them had spared her and her infant son from death.

But when Imaro reached the age of five rains, his mother was forced to depart from the tribe, and the boy was left behind to struggle toward manhood among a people who disdained him.

Imaro closed his ears to the taunts and focused his eyes on the circle of women. *Maybe this will be the*

# Mzee

by Charles R. Saunders

Illustrations by Jerry Eaton

time, he thought wistfully while the younger boys enjoyed their game of mockery.

"Look!" one of the boys cried suddenly, pointing toward the women. Two of them had broken the circle and were hurrying toward the *manyattas*. The singing stopped.

"The *ngombes* are born," the boys whispered excitedly. "The women are going to get Masadu."

That last word silenced the youthful chatter. For Masadu was the teacher of *mafundishu-ya-muran*, and although Ilyassai warriors boasted that they knew no fear, all had at one time in their lives feared Masadu. And it was Masadu who allocated the first *ngombes* to warriors-to-be.

A swarm of unspoken prayers soared to the sky, intended for the ears of Ajunge the Spear-God: *Let me be the one to have one of these calves!* None of the silent entreaties was more fervent than Imaro's. But Imaro had prayed to Ajunge countless times before, and each time he had been answered only with bitter.. disappointment. Inside — in that deep and secret place in which he hoarded his hurts — a voice said to Imaro: *You will not be the one. . . .*

"Yes I will!" Imaro whispered with the fierce intensity of a child who wants.

The two women returned from the *manyattas*. Masadu accompanied them to the circle. The boys strained forward like lion cubs sighting their first prey. Yet they remained where they were; Masadu would never countenance open displays of eagerness outside of training Sessions.

After several moments had stretched into an eternity of expectation, Masadu emerged from the circle. In his arms, he carried a newborn calf, wet, wriggling, bawling in a high-pitched voice.

*He carries only one*, Imaro thought anxiously. *Where is the other?*

Masadu's approach was slow and deliberate, as befitted a senior warrior of the Ilyassai. With cruel clarity; Jua's light picked out the parallel rows of scars that disfigured the left side of Masadu's face. Ngatun the lion had left that mark — but Masadu had slain Ngatun.

Beneath a helmet of braided hair caked with red ocher, Masadu's dark eyes flicked like knife-points from youth to youth. *I will be the one*, Imaro hoped.

Masadu's gaze settled on one of the younger boys.

"Keju," he called. "Come. This one will be yours."

Barely able to contain his happiness, Keju approached Masadu. The warrior knelt and lowered the calf to the ground. The newborn *ngombe* tottered to its feet. Keju's small arms encircled the neck of the calf. Although the expression on his face did not change, Masadu nodded approval as the calf ceased its crying and licked at Keju's face.

Then the warrior lifted the calf again and said to Keju, "Come back with me now. Your *ngombe* needs his mother's milk."

As Masadu led Keju back to the circle of women, Imaro fought down a surge of blighted hope that twisted his heart with a strength undiminished by the

consistency of Masadu's rebuffs.

But there was another *ngombe* giving birth. Masadu would return. And again Imaro would pit his hopes against the iron shield of Masadu's indifference.

Again, Imaro ignored the whispered derision of the younger boys. Again, Masadu emerged from the circle. This time, however, his arms were empty.

*Where is the calf?* Imaro thought uneasily.

"Sifa's calving is troubled," Masadu said to the warriors-to-be. "The women say her calf may be born dead. If the calf lives, it will be weak and useless. It will probably die before the rains come."

Then Masadu looked directly at Imaro.

"This one will be yours," he said.

In his ten rains of life, Imaro had achieved ironclad control over his feelings. But iron can bend. Iron can break.

A *ngombe* that would die before it had a chance to live — tears welled in Imaro's eyes and a cry of despair welled in his throat. The laughter of the other boys stung like the barbs of hornets. Masadu's gaze stabbed at him, probing for weakness. Another moment, and Masadu's probe would be rewarded.

Imaro spun on his heels and began to run. Oblivious to the shouts that rose behind him, the youth raced away from the humiliation that threatened to shatter the iron inside him.

"Let's go after him!" a boy shouted.

"No," Masadu said sharply. "Let him go. He may not come back."

## THE TAMBURURE ENFOLDED IMARO

in a golden embrace. Jua's heat cradled him like a mother's arms. Tall yellow grass whipped softly against his legs as he ran. The Tamburure teemed with life. Grazing beasts of a hundred kinds lifted their heads at the sound of Imaro's passage, then returned to their fodder. A lone boy posed them no threat.

Predators flared their nostrils at the acrid tang of man-scent. Some ignored the familiar, disquieting odor. Others, growling deep in feline throats, bared their fangs in anger at the smell of a human intruder. Of these, some began a leisurely yet purposeful stalk.

Imaro made no attempt at stealth. His *kufahuma*, the unity of senses that enhanced his awareness of all that surrounded him in the Tamburure, meant nothing to him now. Imaro did not care that Ngatun the lion or Chui the leopard would be alerted by the sound of his passage through the grass. The snap of a predator's jaws seemed far more welcome a fate than the prospect of more abuse from the Ilyassai.

He ran on. Sweat bathed his umber skin and soaked the single garment he wore about his loins. His hand brushed against the hilt of his knife that was his only weapon. He did not intend to use it if danger struck. If the Ilyassai would not take him, perhaps the Tamburure would.

It was then that Imaro heard a sound unlike any he had ever imagined he could hear on the Tamburure. It was a high, twanging sound that stitched through the

muted cacophony of animal voices like a needle through yielding fabric — a thoroughly *human* sound that the throat of neither animal nor bird could have shaped.

A combination of fascination and curiosity shouldered Imaro's depression aside. *The twanging sound has to come from an instrument of human design, he*

Masadu returned as Imaro made his way toward the compelling sound. The danger into which he had thrust himself became ominously apparent: he was a boy, armed only with a small knife, and he was alone in the Tamburure. But he was not truly alone: the melodic twanging drew him onward and soothed the emotions boiling inside him.



reasoned. The Ilyassai made such instruments, but they rarely played them. Imaro realized that the music he was hearing could not have been made by an Ilyassai. For the tones were peaceful — and there was nothing peaceful about the Ilyassai.

Imaro strained his ears to locate the source of the sound. It came from the direction of Jua's rising. The youth scanned the Tamburure in all directions. None of the animals in the great herds paid any heed to the alien sound. It was as though the music were meant for Imaro's ears alone.

The *kufuhuma* deeply ingrained by the teachings of

body, naked save for a length of bark-cloth gathered about his loins, was lean and gaunt. Yet he was far from feeble. Like an acacia tree standing alone on the Savannah, he had been weathered by many rains, but those rains had not withered him.

Neither ornaments nor distinctive hairdressing marked the man as a member of any of the tribes of the Tamburure. *This one is an outsider*, Imaro thought, *like me. . . .*

Then the boy's attention shifted to the lions. And a new thought struck him: *Ajunge!* The elders of the Ilyassai often said that the Spear-God walked with the

**W**HEN IMARO finally reached the origin of the music, he stared in wide-eyed wonder. Seated in the midst of a stretch of ankle-high grass was an old man. The man's fingers plucked lightly at an instrument fashioned from a gourd, a stick, and a single string. This man was not alone. . . .

Ngatun the lion was there: two females and a full-maned male. The lions sprawled lazily, paying no attention to the man who sat so casually among them. They gazed at Imaro, who had just emerged from a screen of higher grass. But the glint of the hunter was gone from their yellow eyes. Like Imaro, Ngatun had been lulled by the peaceful sound the instrument made.

The old man looked at Imaro and smiled. His black face was seamed with wrinkles, but his eyes shone with a vitality that could not be dimmed by age. His hair, receding from his temples, was a tight, kinky cap, white as the clouds of the dry season. His



spirit of Ngatun. Yet this man carried no spear, nor any other weapon Imaro could see.

Still, Imaro spoke the Spear-God's name. And the old man's fingers stilled, and he laughed.

"Child, I am no god," he said in a low, resonant voice. "I am only an old man, trying to live another rain."

"But if you are only an old man, why does Ngatun not kill you?"

"I know Ngatun, and Ngatun knows me," the man replied enigmatically. "Now sit, child. You have run far and are in need of rest."

The truth of the old man's words was made apparent by Imaro's abrupt awareness of his own fatigue. He sank down in the grass, but he kept a wary eye on the three lions. None of the great cats moved. As though from a great distance outside himself, Imaro wondered how he could sit so close to Ngatun, taker of cattle and tester of courage, without feeling the slightest stir of fear.

"The lions will not harm you," the old man said. "Not as long as I am here."

"If you are not Ajunge, who are you?" Imaro asked.

"I am called 'Mzee'."

Imaro frowned in puzzlement. *Mzee* was not a name; it was a title given by the tribes of the Tamburure to elders who had gained wisdom from their rains.

Before Imaro could voice his perplexity, Mzee spoke, "Child, why do you run alone in the Tamburure? Does your life mean that little to you?"

Imaro looked at the ground. He had no intention of peeling away the scabs that had encrusted the wounds the Ilyassai had carved in his soul. But now there was the old man's smile and the soothing sound of the gourd-and-string instrument. And Imaro found himself raising his head and meeting Mzee's peaceful gaze. He began to talk, words tumbling swiftly from his mouth. He told of his life among his mother's people, from the day she had departed the *manyattas* to the moment Masadu had said: "This one will be yours."

As the boy spoke, Mzee listened quietly. From time to time, he plucked a random note from the string of his instrument. The three lions slept.

When Imaro's tale was done, Mzee sighed.

"So young. . . yet you want the Tamburure to take your life," he murmured.

"Mzee," Imaro said, suddenly straightening. "Who are your people? Where do you come from?"

"My people are all who raise no hand against me. I come with the wind and go with the rains. I am one with the land and the water, the things that grow and the things that kill to eat. I am Mzee, and I follow the path of Ingulu."

Imaro's eyes widened at the mention of the High God's name. Ajunge was the god of the Ilyassai; Ingulu was the god of the sky.

The boy's small strong hands reached out and clutched those of Mzee.

"Mzee. . . will you take me with you? I want to come with the wind and go with the rains and never have to see Masadu and the others again."

Mzee saw the terrible, naked pleading in Imaro's eyes. The old man regretfully shook his head. He spoke before Imaro could voice his protest.

"Child, there is something you are forgetting. You do have a *ngombe* — Sifa's calf."

"But Masadu said it would be born dead, or else too weak to live! What kind of *ngombe* is that? Oh, you are like all the others! You don't want me!"

Face twisted in hurt and frustration, Imaro sprang to his feet and whirled away from Mzee. But before his legs could carry him away, the old man's voice cut through the anger that roared in the boy's ears.

"As you do not want your *ngombe*?"

Slowly, Imaro turned to face Mzee again. There was no hint of reproach in Mzee's eyes. But those eyes were as compelling as the old man's words were. And those words hung almost tangibly between man and boy long after the sound had faded. And Imaro knew



what he must do.

"I must go back," he said softly, giving voice to his first major decision. "But Sifa's calf may be dead."

"No. I promise you, your *ngombe* lives and awaits you now."

Mzee stood then, his body unfolding with a fluid grace that belied his age. Imaro looked up at Mzee, who suddenly seemed to tower as tall as a tree. The three lions also rose and rumbled deep in their throats. For a single moment, that sound brought a metallic taste of fear to Imaro's mouth. Then Mzee's hands reached down and gently cupped the face of the youth.

"Child, you have seen too much pain; and you are afraid to go on living. But there is more to living than what you can see. You cannot see now what you will grow to become. There is greatness within you, child. But you must push aside your pain to find it.

"Now you must go to your *ngombe* and forget me. For if you think of me too much, you will want to follow me. And that cannot be. . . I can feel it in the wind. I must go, and you will not remember me. But one day, when you become what you are meant to be, you will see me again."

Slowly, Mzee passed his hands over Imaro's eyes.

**I** MARO BLINKED IN THE SUNLIGHT. ALMOST instinctively, his hand curled around the hilt of his knife. His eyes searched the grass surrounding him, but they found nothing unusual there. Then he realized that some of the grass was slowly unbending,

as though someone or something had been there only moments before. And the sharp smell of Ngatun the lion reached Imaro's nostrils. His *kufahuma* told him Ngatun could not be far, since he could see a trail of straightening grass leading away from him.

"What happened —" Imaro wondered. He tried to remember, but could not. Then another thought struck him with the force of a well-hurled spear. "My *ngombe!*"

The sun was beginning to sink as Imaro sprinted madly across the Tamburure. It was as though he were racing Jua toward the *manyattas*. The animals of the Tamburure followed him with their eyes, but none — not even the fanged ones — hindered his progress. It was as though time had paused.

When he reached the *manyattas*, Imaro saw that the women still formed their circle. Keju and some of the other boys ran toward him, but he easily outdistanced them. He heard the women singing. It was a sad song of death hovering near on vulture wings, preparing to descend. Above the women's voices, he heard the cry of a calf.

Imaro pushed his way between two of the women. They cried out at the strength in the arms that shoved them aside. Sifa lay in the grass. Near her, a woman and a man bent, peering closely at a small, unmoving shape. The man was Masadu.

*Sifa's calf lives!* Imaro exulted. He covered the few remaining strides toward the calf like a leopard pursuing a gazelle.

The newborn *ngombe* attempted to stand, as most calves do within moments of birth. But this one's legs were too feeble. Bawling piteously, the calf collapsed.

Imaro brushed past Masadu and the woman and enfolded the young *ngombe* in his arms.

"I am here, *kulu*," Imaro murmured, speaking the Ilyassai word for *friend*. "You will not be alone ever

again. . . ."

A hand clamped heavily on the boy's shoulder and hurled him away from the calf. Imaro fell hard, then rose immediately to face Masadu.

"You told me this one would be mine," Imaro said, struggling to keep his voice steady.

"And when I did, you ran away," Masadu returned. His face was like a marred mask. "Your *ngombe* needed you, and you ran like a whipped dog."

"I am here now."

Masadu drew his *simi*, the short sword all Ilyassai warriors carry at their sides. He extended the point of the weapon until it touched Imaro's throat.

"Are you willing to die for your *ngombe*?" Masadu asked quietly.

"Yes."

Something flickered briefly in the warrior's eyes. It might have been a hint of grudging approval — it was gone by the time Masadu lowered his *simi*.

"There will be a beating for you for deserting your *ngombe*," Masadu promised. "Do not let that happen again."

Imaro nodded. He had taken many beatings from Masadu and had yet to cry out. Another such beating would not matter.

"See to your *ngombe*, then."

Imaro looked again at his new charge. The calf was weak, yes — but it was alive. He, too, was weak once. But he had made himself strong. His *ngombe* would also be strong. He would care for it with the part of him that had not yet been burned away by bitterness.

He lifted his calf and carried it toward Sifa. A sudden wind blew against his face, and for a moment Imaro could hear something — a deep soothing voice, the strains of distant music. Then the wind was gone, and the last trace of memory of Mzee vanished like a whisper of dying magic. □

### Write on!

Got a question about an article? A subject you'd like us to cover — or *not* cover? What do you think of the magazine you're reading? Drop us a line at "Out on a Limb," P.O. Box 110, Lake Geneva WI 53147. We'll read every letter we get, and we'll select certain letters of general interest for publication — maybe even *yours!*

CUNNING DIPLOMACY  
STRATEGY DECEIT

# EARTHWOOD

These are the challenges of . . .

SET IN A FANTASY WORLD, EARTHWOOD IS A STRATEGIC PBM GAME ASSUME THE ROLES OF KINGS, WIZARDS, OR MIGHTY HEROES WITH TROLLING ALL EARTHWOOD, EITHER BY CONQUEST, TACT, DIPLOMACY THOUSANDS OF PLAYERS ALREADY ENROLLED. NEW GAMES STARTING 2 WEEK TURN-AROUND \$3/TURN. REGISTRATION FEE STILL \$10 MAP, AND 1ST 2 TURNS FREE! (RULES ONLY \$5)

WHERE 25 PLAYERS THE GOAL OF CON — OR ALLIANCE — CONSTANTLY — INCLUDES RULES,

The saga continues . . .

## DAWN OF THE ANCIENTS

CSI'S NEWEST RELEASE — SEE NEXT ISSUE

CSI  
PO Box 431166  
Miami, Fla 33243-1166  
305-255-6070

## Game review

# Battlesuit salutes infantry

No matter which era in history one examines, the "poor bloody infantry" are the ones who secure and hold territory during warfare. This axiom holds true in future histories as well, as demonstrated by the *BATTLESUIT™* game. This product, from Steve Jackson Games, presents a man-to-man, futuristic combat system based in the same world as the *Ogre™* game. For those of you who were stored in closets several years back, the *Ogre* game (also produced by SJG) is a cybernetic tank combat system

The components are eye-catching, if nothing else — starting with a snazzy box cover that vividly depicts what "elimination" means in combat. The mapsheet offers the first clue that the *Battlesuit* game is something different. It is an ugly lime-green colored thing with brown-tinted terrain features and no hexagonal pattern superimposed on it. In place of the hex grid are "staggered points" that regulate movement and define ranges. This change is aesthetically pleasing, but is really just

powered-armor infantry when fighting unarmored infantry, involving 33 units. Each of the scenarios is fairly well balanced and requires about an hour to play.

During the play of the game, both players are busy even when one of them isn't shuffling counters around the map. The non-moving player has to be alert for "reaction fire" openings; gambling on whether your opponent will move closer could cost you a target if he ducks into the forest instead of into easier firing range. The moving player has to wait about one second before moving his piece on to the next point or firing; this gives the non-moving player a chance to get the "jump" on firing first. During a turn, each unit may move and fire, fire twice, or target an enemy (giving friendly units a bonus to hit the targeted unit) and fire. Each unit may also fire during the moving player's turn, as described above, but does so at a penalty.

Combat, which occurs frequently, is very simple and bloody. To resolve an attack, the players subtract the target's ECM rating from the firer's attack strength. Modifiers are added or subtracted for range, morale, terrain, and targeting (they are not overdone, though; no rules give a -3 to hit because someone's shoelaces were untied). The final modified attack strength is cross-referenced with a two-dice roll on the Combat Results Table to get the end result.

Combat results range from no effect to outright elimination (as shown on the box cover). More often the target is affected either physically or psychologically, and sometimes both results occur at once. Damage takes the form of "shock," which can lead to "panic" (if a morale check is failed), or physical deterioration of a battlesuit by degrees. After a few games it becomes readily apparent that having a damaged battlesuit is more of a handicap than being unarmored, and for a damaged unit elimination isn't too far behind. The attacker is never affected by the result on the CRT — but a retaliatory strike can be murderous.

The *Battlesuit* game has extremely simple mechanics, but the hidden tactics make it a game of cat-and-mouse as both players feint and probe, each looking for weaknesses in the opponent's force. Guessing and luck are a part of the game, but players have to be on their toes continually watching for openings. This is not a beer-and-pretzels game; it's too high-keyed for that classification. "Blood and guts" or "cardboard carnage" would be more appropriate.

The game does lapse in its logic at some

---

*Guessing and luck are a part of the game, but players have to be on their toes continually watching for openings.*

---

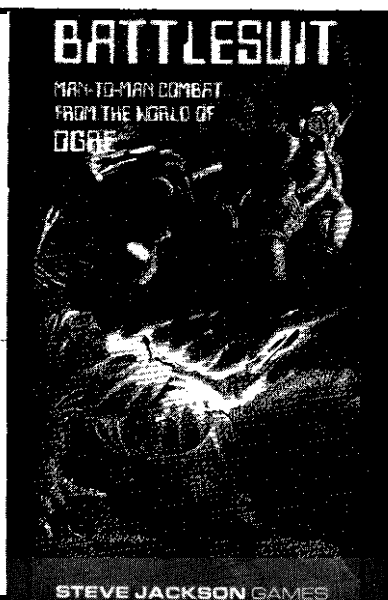

that helped to launch the "microgame" phenomenon. The *Battlesuit* game shows the what wartime activity between infantry forces was like when high-powered vehicles like the *Ogre* are not around.

This game uses the same "historical" background as the *Ogre* game, but this appears to be more of a sales vehicle than a useful aspect of the game itself. Nowhere does the game box say that *Battlesuit* is not compatible with the *Ogre* game, though it does say that it uses a new tactical mapping system. Prospective buyers of the *Battlesuit* game should disregard that it is a historical sequel to the *Ogre* game, because the two systems aren't compatible.

The *Battlesuit* game does play very well. It stands on its own merit as a game that can be played several times before all of its possibilities are exhausted. (Can you say that about the last game you played?) And, it's easy to see that the game is expandable. In the final analysis, it's a game well worth picking up.

another method for accomplishing the same purpose as a hex grid, not an innovative system.

Most of the playing pieces are  $\frac{3}{4}$ " square, but some are smaller and used for bookkeeping purposes. Each piece represents one man (armored or unarmored), a piece of equipment, a building, or a wreck. The counters are very nicely done with unit identification printed at the top, a silhouette of the unit in the center, and containing the important characteristics of the unit — attack strength, ECM (Electronic Countermeasures) rating, and movement factor. The black-on-red and white-on-black color schemes are very easy on the eyes.

The rules booklet is practically glitch-free and covers almost every aspect of play that might need consideration. It has a pull-out sheet (which comes in very handy) showing all of the combat and line-of-sight tables, and supplies six scenarios ranging from training drills involving only 14 playing pieces to a lesson in the deadliness of

points. Not all infantry should react to stress situations in the same way, but the game treats morale very simply: everyone acts the same. This game is about men, not cybernetic juggernauts who weren't programmed for retreat. A little more work could have been put into the morale rules without dirtying the game system unduly. One quick fix would be to give each infantryman a "self-preservation rating" that would be added to or subtracted from the morale-check die roll, giving each counter a "mini-personality." Players would then randomly pick units of the various types

prior to play and not have control over the mental stability of their troops. As the rules stand now, a man will never recover from panic if the optional "loss of command control" rule is used and the force has already lost a command unit. So much for heroes like William Mandella (of *The Forever War*) in the world of *Ogre*.

It also seems strange that anyone can distinguish a command, ranger, assault, or standard battlesuit from any other, but cannot tell the difference between recon, attack, and bomb drones. A rule that covers spotting or identifying units seems to

scream for inclusion.

Nitpicking aside, *Battlesuit* is a fun little game. Those who are looking for a "realistic" simulation will be disappointed, but if you like "shoot-'em-up" games, this one fills the bill well. Hopefully future expansions of it will highlight the personal facets of combat rather than treating humans like programmable death machines.

The *Battlesuit* game is available from retail hobby shops for \$5, and from the publisher (add 50 cents for postage and handling on mail orders).

— Reviewed by Jerry Epperson

## Game review

# Phantasy Conclave: Only phair

Evolving from its origin as the house rules for a gaming club of the same name, *PHANTASY CONCLAVE* is now available in a professionally produced format. The product consists of three 20-page booklets (fully typeset and illustrated), an 8-page Gamemaster Guide produced on a dot-matrix printer, a single page of dot-matrix Player's Notes, and an assortment of ten high-impact dice made by GameScience. The components are contained in an illustrated, one-piece cardstock box.

To some extent, the rules of the game seem to have been derived from the *ADVANCED D&D* game system, though many departures from that game exist as well. However, little effort has been made to fill in the background for the Gamemaster. The system consists mostly of rules and descriptions of player character races; no support material (descriptions of monsters and treasures that can fill up a dungeon, for instance) is provided, and the playability of the system is substandard as a result.

The physical product is equally substandard. Two pages of rulebook errata, produced on a dot-matrix printer, are provided. Ambitious game owners with a desire to be organized may find a way to cut the errata sheets into sections, pasting the strips over the incorrect pieces of text in the original version of the rules. This technique of physically covering up errors could be a blessing in disguise if one could also use the errata to hide the interior illustrations, which are so poorly crafted that they are almost painful to look at.

Another drawback to the quality of the components is the lack of character sheets. The game rules state that these sheets are available — if so, why wasn't a sample included? — but no information on how to obtain them is given.

Quibbling, however, about the physical components of the game is simply that. The more important aspects of the game are the rules and background materials that serve to create the fantasy world in which play

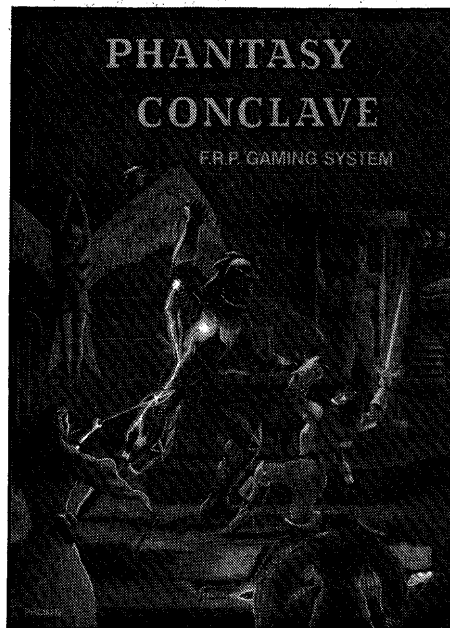

occurs. In these respects the product stands up somewhat better when compared to other FRP systems on the market, but it still suffers from superficiality and a lack of completeness. The world of *Phantasy Conclave* is called Arth, an environment similar in many ways to the Earth of A.D. 1300, with the so-called known world corresponding to Europe, Africa, and Asia of that time frame. The one map provided with the game depicts some geographical alterations, though.

Other than the geographical information provided, the only background material supplied is a brief history of the races of Arth — men, halflings, elves, dwarves, and gnomes. At one point in this history, a city-state of conquering wizards had devastated its enemies with an invention called the Power of Thunder. To stop these wizards, a magic-working conclave of all the races was formed; the conclave succeeded in altering the world so that such inventions would no longer be possible. One of the results of this

***No ranges are supplied for missile weapons, leaving up to the GM's judgement whether a sling with stones outranges a sling with bullets.***

alteration was the loss of inherent racial magic in mankind, while another result was the appearance of new forms of life, both monstrous and intelligent, adding the races of *aerlings* and *meren* to the sapient society.

The brief descriptions of each race are the only background given. A system of coinage is mentioned, as are a brief list of prices of common objects and an indication of wages. But neither statistics nor characteristics for monsters or animals are available, and precious little guidance is provided for anything else. The GM Guide contains a *very* brief scenario for three players, as well as some sketchy notes for creating a town in which to set more action. Advice on converting other game systems' scenarios into terms usable with *Phantasy Conclave* is also given. Nevertheless, this is definitely not a game for the GM who is reluctant to roll up his sleeves and work at or experiment with the system.

In this game, only four character classes exist: fighter, scout, healer, and wizard.



Characters are assumed to have been raised from childhood as members of one class only, and are forever cast in that mold. Magic comes in colors, and each color is peculiar to a particular race or class, with some exceptions. Humans have no racial magic, but an individual man can learn, under the right circumstances, one racial magic spell from each of the other races. Halflings also have no racial magic but are largely resistant to magic and poisons used against them. Halflings cannot use any magic at all, though, and so tend to become scouts, since this character class is likewise unable to use magic. Members of the race of meren are forbidden to be scouts, but the other classes are open to them.

Racial magic consists primarily of spells that are helpful to the everyday activities of each race; some specific spells are useful in combat, though. Each race has about half a dozen such spells available, with little or no overlap. For example, fighters use crimson magic; there are nine of these spells, and all are combat-tactical in nature. Golden magic is the province of healers. There are 38 spells in this category, counting those with reversible effects as separate spells. Some of these spells are useful in combat, but most are better employed at other times. Wizards use cobalt blue magic, which includes seven minor cantrips, eight detection spells, and fifteen major spells — some of which are devastating in combat.

Characters have six primary attributes, each of which is determined by rolling, 4d6 and totaling the three highest results. The primary attributes are physique, intellect, wisdom, dexterity, endurance, and appearance. From these scores, various secondary attributes are calculated, the most important of which are physical aptitude level (PAL), physical aptitude rating (PAR), magical aptitude level (MAL), and magical aptitude rating (MAR). A character's PAL is the total of his physique plus endurance, plus any bonus he is due for high endurance; PAL represents the maximum level of the character's PAR, which diminishes as the character expends strength and suffers physical wounds. Similarly, MAL is the sum of intellect plus wisdom plus any bonuses; MAL represents the maximum level of MAR, which decreases as spells are cast or the character takes damage from magic. The reduction of PAR to less than zero means that the character is dying, and his PAR will continue to drop unless he is aided. Death results when a character's PAR reaches -10. PAL and MAL can be increased by experience rolls at the discretion of the GM; lost PAR and MAR points are recovered by rest and healing.

Combat is resolved by the roll of decimal dice (d10). The PAR of the attacker is cross-indexed with the armor class of the defender on a chart to determine the roll needed to score a hit. This value may be modified by racial characteristics, training, or other temporary conditions; If a hit is scored, weapon damage is rolled, and the result is subtracted from the defender's PAR.

Combat is not simultaneous: one party is the attacker, a status determined at the start of each six-second melee round and dependent largely upon the luck of the die. At the start of the round, players declare any intent for their characters to use magic. Then action is resolved in this sequence: 1) attacking missile fire, 2) defending missile fire, 3) attacker's weapon attack (including a fighter's crimson magic), 4) attacker's magic use (all other forms of magic), 5) defender's magic use, 6) defender's weapon attack (again including crimson magic), 7) defender's movement, and 8) attacker's movement. The rules state that, with the exception of users of crimson magic, any magic caster who is hit in a round cannot use magic later in that round. There is a notable advantage to being the attacker because the player of this character resolves all of his attacks (including magic) before the defender takes any action other than shooting missiles. The use of magic in combat is limited mostly to the fighter's crimson spells — for example, Death Touch and Magic Missile — and to the wizard's cobalt blue spells — Energy Whip or Cobalt Blast, for instance. To cast a spell merely requires stating the intention to do so, expending the appropriate amounts of PAR or MAR points, and avoiding the taking of damage, in that round of combat. The effects of the spell are always felt by the target, and range from annoying to devastating.

Combat can proceed fairly quickly, but only once the players and the GM have settled on what they are doing. The rules are really very sketchy. No system for regulating movement is given, except to allow attackers the opportunity to move twice as fast as defenders: In one round an attacker can move one-fifth of the distance he could normally move in one minute (note that a melee round is one-tenth of a minute). Weapons are classed as type I through V, with all weapons in the same category inflicting the same damage (1d4 to 1d12) regardless of actual type. No ranges are supplied for missile weapons, leaving up to the GM's judgment such questions as whether a sling with stones outranges a sling with bullets.

This sort of sketchiness in the combat rules is not limited to this area; it appears in all aspects of the game. Learning new spells or skills and gaining weapon training are only perfunctorily treated. Life when not adventuring is hardly addressed, and a lack of care is seen in those elements that are discussed. For instance, the daily wage for a laborer is one silver coin, which happens to be the cost of a day's field rations. A change of clothes — a concept which remains undefined — costs two silver coins, but a light cloak costs five times as much. Even more preposterous is the fact that a backpack costs 15 gold coins, or 75 times the cost of the clothes. In modern terms, it would cost \$1500 for a pack to cart around a \$20 outfit.

The overwhelming reaction to this game is a feeling of "Is that all there is?" —

especially when considering the game's price of \$19.95. The package of dice included is a \$10 retail value. But, even at that, \$9.95 for the remainder of the components is no bargain. The game, to the extent that it has been developed, has some interesting ideas, but so little of the necessary supporting detail has been delineated that the game cannot really compare to other products of this type on the market. *Phantasy Conclave* is overpriced for what it supplies, so buyers should not casually purchase it.

The game is available by mail order from Phantasy Conclave, P.O. Box 861, Bensalem PA 19020.

— *Reviewed by Steve List*

---

## The forum

(From page 6)

through. But there is nothing to stop the gods of the other eight alignments from bestowing paladin-like powers on those who champion their cause, too. It would require the character to adhere just as strictly to his/her alignment as the true "paladin" and similar penalties for backsliding. So all you anti-paladins can breathe a sigh of relief — you *can* exist after all.

Jeff de Remer  
Jefferson, Ore.

\* \* \* \*

I would like to applaud Peter Bregoli's statement in The Forum of issue #84. However, it is also true that The Forum is needed for the more lengthy letters of criticism and comment. Elsewhere in that same issue is a letter to Out on a Limb saying that *that* column has changed for the worse to a worthless place where nit-picking letters are printed and the Forum a mere replacement, a poor one at that, under a different, unfitting name. But it seems to be that Out on a Limb, besides being a relatively traditional space where minor errors are corrected, is more a column where letters are directed to the editor(s) specifically, whereas the Forum is where gamers can speak their mind to other readers. Take another look; do you see any editorial replies in the Forum? Give the editors a chance, I think they've thought through their choices well.

Definitely the Forum is a place for new ideas, but these new ideas must be the briefest of the bunch. Most new ideas worthy of being printed grow quickly to become full-fledged articles that grace other pages of the magazine.

The Forum is absolutely necessary as the location for the more lengthy letters of criticism, and that's why those letters are most commonly found there. Look at your most recent issues of the magazine, the ones without the Forum; see the astonishing lengths of those letters, which are more directed at other gamers, and you feel pity for the publishers in their hunger for space.

So let the Forum contain what the editors think needs to be there. Most certainly, new ideas from readers represent an important part of DRAGON Magazine, but if your ideas are really that good, think about writing full articles on them. Remember, criticism and commentary on previous issues or present concerns are a vital part of any magazine — DRAGON even more so.

Kirk Everist  
Dubuque, Iowa

# More than just 'roll'-playing

EXPERIENCE THE BEST IN  
ROLE-PLAYING WITH

# the Compleat Fantasy Series



### The Compleat Alchemist

The authoritative guide to Alchemy, containing formulae for the creation of elixirs, powders, potions, dusts, and gasses. Also new information on the creation of golems, homonculi, machina, and advanced operations such as: wind ships, crystal balls, and magic mirrors, etc.

**Retail Price: \$7.50**

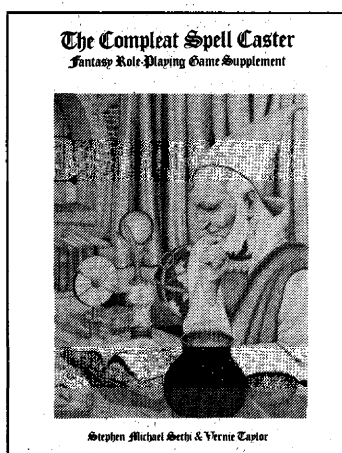

### The Compleat Spell Caster

Four new classes of spell casters, including: the witch, mystic, necromancer, and sorcerer. Plus new information on the hierarchy of demons, familiars, runes, symbols, circles of protection, magic items, and much more.

**Retail price: \$7.50**

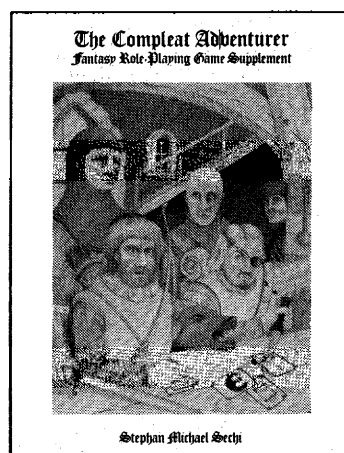

### The Compleat Adventurer

More new character classes, including the beastmaster, bounty hunter, buccaneer, gladiator, harlequin, knight, martial artist, rogue, and others... A wealth of information for the avid player or game judge.

**Retail Price: \$7.50**

The Compleat Fantasy Series of supplements features many new and exciting character classes, spells, and magic items for the experienced player or game judge. Easily adapted to most fantasy role-playing systems, these supplements can be used to add variety to any on-going campaign.

Available at finer hobby stores or send \$7.50 + 50¢ postage per book to:  
Bard Games, P.O. Box 7424, Greenwich, CT 06836

Now Available  
at  
Waldenbooks

**Bard Games**  
Where Fantasy Becomes Reality

Foreign buyers  
please send checks  
drawn on U.S. banks.

**Plan NOW to Attend!**

# GEN CON 7



GAME CONVENTION

**Thur., Fri., Sat. & Sun., Aug. 16 thru 19, 1984**

*University of Wisconsin, Parkside Campus  
Kenosha, Wisconsin*

Come join in the fun, fantasy and festivities at the world's oldest, largest and best attended gathering of adventure role-playing gamers.

## **Join in the fun and excitement of playing . . .**

- Adventure Games
- Role-Playing Games
- Games Using Miniatures
- Board Games
- Computer Games
- The AD&D® Open Tournament

## **Enjoy the excitement and variety of . . .**

- The More Than 100 Exhibits
- The Fantasy Art Fair
- Workshops
- Seminars
- Demonstrations
- Movies
- The Miniatures Figure Judging

**Look for . . .** the complete Registration-By-Mail Brochure in the July issue of DRAGON® Magazine.

**Admission . . .** For Gamers who register by mail, \$20 for all 4 days of fun and games. For those who register at the Convention, \$25 for all 4 days. Individual daily registration, \$10 per day. For Non-Gamers of all ages who would like to see first-hand what adventure role-playing games are all about, \$1 per person per day.

**Adding Another Dimension**



# Ares

SCIENCE-FICTION GAMING SECTION





## CONTENTS

**ARES Log** . . . . . 70

### KNOW YOUR ENEMY

**James Ryan** . . . . . 71  
A guide to super-villain groups.

### A WORLD GONE MAD

**James M. Ward** . . . . . 74  
The Moon of the GAMMA WORLD® game.

### FAST AND DEADLY

**Carl Smith** . . . . . 78  
New starships for the STAR FRONTIERS® Knight Hawks game.

### INTERSTELLAR ATHLETES

**Michael Brown** . . . . . 80  
A TRAVELLER® game variant career.

### STARQUESTIONS

**James M. Ward** . . . . . 83  
GAMMA WORLD game questions are answered.



#### ON THE COVER

Superhero game campaigns would not be complete without a nice assortment of supervillains to make superheroes' lives more complicated. Ideas for creating super-villains and supervillain groups are discussed in "Know Your Enemy," by James Ryan. Cover art by Jeff Butler.

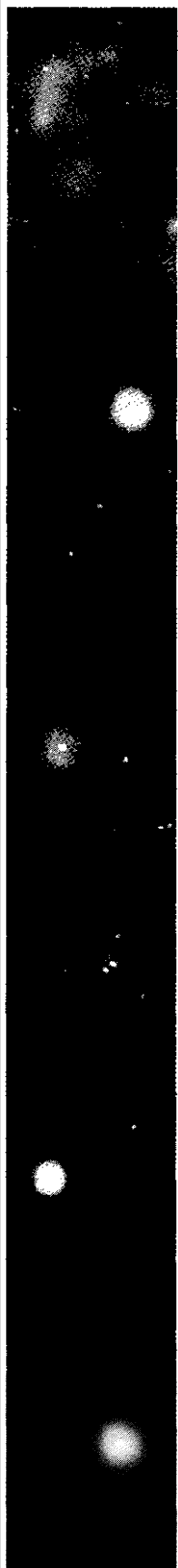

Some of us are natural pessimists (like your editors) and believe the worst outcome will develop from any situation. Some people, however, are optimistic pessimists: the worst might happen, but it would be a real gas to see it. Everyone who cheers when the Martians start blasting away in *War of the Worlds* knows what we're talking about.

With that cheerful thought in mind, we offer an apocalyptic vision of the Moon's future, "A World Gone Mad," for the GAMMA WORLD game system. Heft your lasers, lock your bubble car doors, and get set for a wild ride.

Also in this issue, superhero game players will find some thoughts on constructing supervillains from scratch; these suggestions will work well for those playing the new MARVEL SUPER HEROES™ game. New starships for the STAR FRONTIERS Knight Hawks game are given a going-over, and the athletes of the Imperium make their appearance for the TRAVELLER game. Our regular "StarQuestions" column answers some readers' questions on the GAMMA WORLD game as well.

The mail that we've received on the ARES™ Section to date has been quite good. A number of people are sending in articles for the STAR FRONTIERS game and other science-fiction game systems. What science-fiction games would you like to see covered here? What topics would you like for the ARES Section to cover? Pick up your pen and write a letter to: ARES™ Department, Dragon Publishing, P.O. Box 110, Lake Geneva, Wisconsin 53147. We listen to our readers.

*The editors*

## ARES™ Section 86 THE SCIENCE-FICTION GAMING SECTION

**Editors:** Mary Kirchoff & Roger Moore

**Design director:** Kristine Bartyzel

**Editorial assistance:** Georgia Moore

**Graphics and production:** Roger Raupp, Marilyn Favaro

All materials published in the ARES Section become the exclusive property of the publisher upon publication, unless special arrangements to the contrary are made prior to publication. Unsolicited manuscripts are welcome, but the publisher assumes no responsibility for them and they will not be returned unless accompanied by a stamped, self-addressed envelope of sufficient size and volume.

ARES is a trademark of TSR, Inc.'s science-fiction gaming section in DRAGON® Magazine. All rights on the contents of this section are reserved, and nothing may be reproduced from it without prior permission in writing from the publisher. Copyright ©1984 TSR, Inc.

GAMMA WORLD, DRAGON, STAR FRONTIERS, and POLYHEDRON are trademarks of TSR, Inc. Traveller is a trademark of Game Designers' Workshop. Marvel Super Heroes is a trademark of the Marvel Comics Group. Grav-Ball is a trademark of FASA.

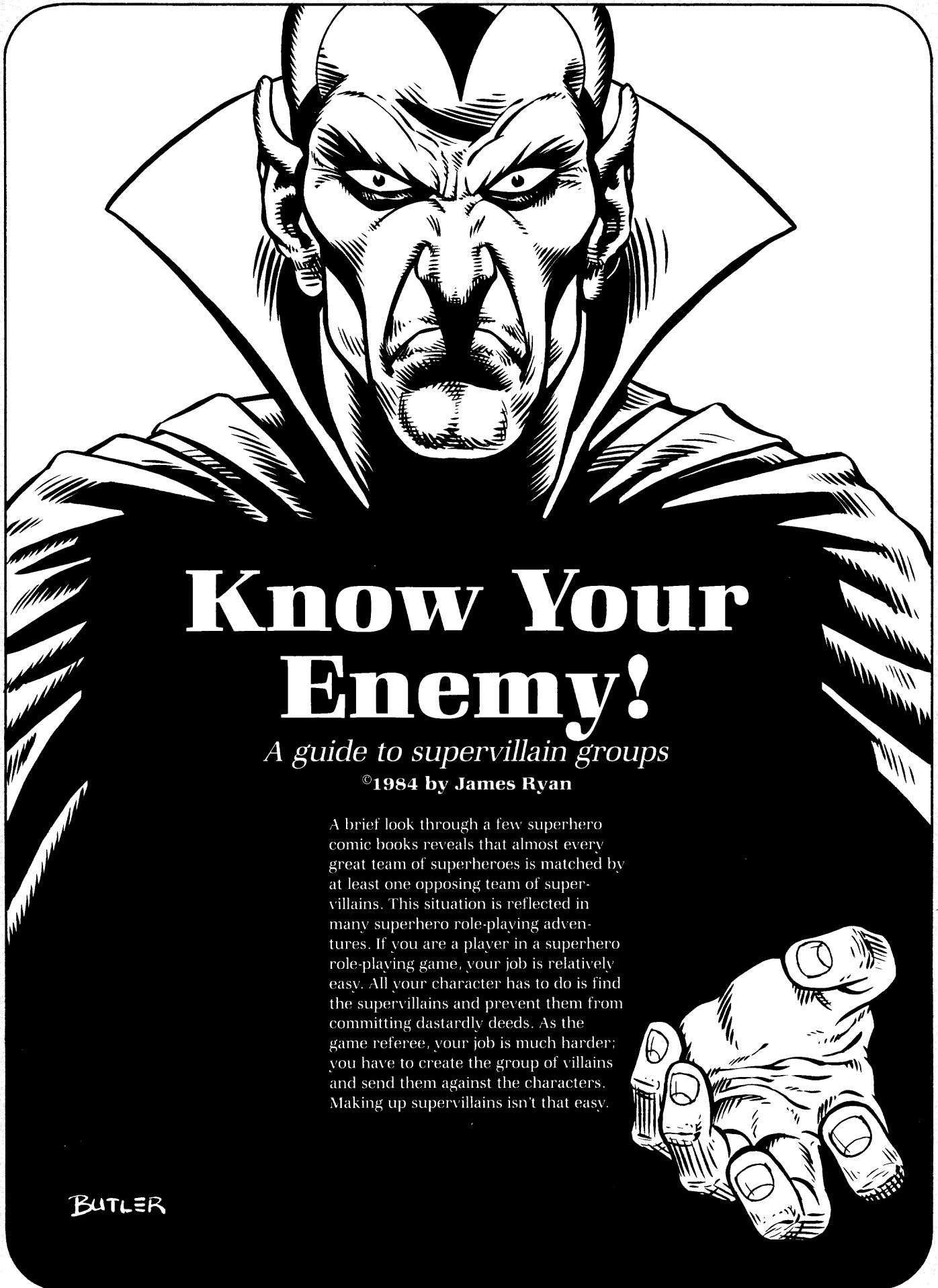

# Know Your Enemy!

*A guide to supervillain groups*

©1984 by James Ryan

A brief look through a few superhero comic books reveals that almost every great team of superheroes is matched by at least one opposing team of supervillains. This situation is reflected in many superhero role-playing adventures. If you are a player in a superhero role-playing game, your job is relatively easy. All your character has to do is find the supervillains and prevent them from committing dastardly deeds. As the game referee, your job is much harder; you have to create the group of villains and send them against the characters. Making up supervillains isn't that easy.

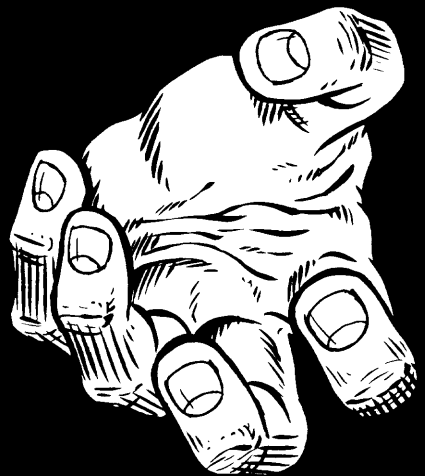

BUTLER

No group of supervillains can exist in a vacuum. Each such group must have both a purpose in life and the resources to carry out its plans. These factors determine how such a group fits into the world, what crimes it commits, and how it deals with superheroes.

Two types of supervillain groups are dealt with here. A "small" group is a maverick organization, usually tightly knit with no more than ten members (six is average). The supervillains in this group are each about equal in terms of powers and experience with the superheroes they most frequently fight against. The members are generally autonomous, relying upon their own personal resources. A small group tends to surface only as the opportunity to commit crimes arises. These groups rely upon close contact between the members and their interdependence to keep everyone in line.

A "large" group, by contrast, relies on a fixed and constant income. This group is essentially a gang of mobsters which may or may not have superpowered members. What the gang lacks in supervillains, it makes up for in numbers of personnel and in the widespread nature of its operations. Although a superhero group can easily handle a few muggers, an army of pickpockets is another thing entirely.

The reasons for forming a small supervillain group will determine the direction such a group will go and what sort of *modus operandi* it will follow. The following are some possible reasons why a small group might be brought into being in the first place.

**Personal gain:** One common reason for forming a supervillain group is merely for the want of booty. The supervillains will go after new and different treasures, moving on to bigger and better things as they become more successful and greedy. These groups generally try to avoid heroes, fighting the heroes only when challenged and attempting to leave the scene quickly, as opposed to using the defeat of a superhero to their advantage. Unless there is a very charismatic member who can give the group direction, leadership and group cohesion will be very shaky.

**Superleader:** This group exists because one villain wills it into existence. This villain should be very powerful, having more experience and proficiency than any individual superhero (although lower-level villains working for the leader will generally be weaker individually than the superheroes they face). Wherever the super-

leader leads, the group will follow. This villain's motives will need to be developed in detail, for it will be that being's aims that dictate what the group will go after and what this will mean for the superheroes facing him.

In my superhero game campaign, the heroes all dread the name of Terminator, who is the leader of a few evil groups scraped together to further his aims: extermination of all superbeings (and to this end, he has had a few successes). In some cases, as with Terminator, the supervillain leader may be powerful enough to reappear without a group of criminals to back him and still give the heroes trouble.

**Fraternal:** Villains in these groups share a common bond that affects their criminal style, and likewise their aims and reactions to their law-and-order competition. Some examples of fraternally oriented supervillain groups include those built around villains who are all martial arts experts, all inventors, all mutants, all aliens, all of one nationality, all from similar origins (perhaps the same origin), or all hold the same religious and political beliefs. These groups will be similar in size and structure to those motivated by personal gain, although what involvement they will have with superheroes will depend on their general nature and bent.

Some fraternal orders may be so offended by one type of superhero (the way a group of Communist superbeings would react against superheroes who uphold a capitalist American way of life, or the way religious villains feel about "heretics") that they will not be satisfied until that superhero is wiped off the face of the earth.

An example of a fraternal villainous gang from my own campaign is Mercenaries Unlimited, a group of women who were trained in the different armies and terrorist organizations of the world. Their bond is their sex and their powers, all of which pertain to well-trained soldiers.

**Mercenaries:** These groups are brought together by some outside force to accomplish a job. They will be united for the sake of money and set to accomplish a task that they were paid for. Their powers will be specified for the job in mind and will most likely be powers that directly counter the powers of the superheroes who will face them. These groups rarely stay together after a few missions, although individual members will pop up now and then.

One exception in my campaign world are the Smashers. Originally organized

to kidnap a rich man for a rival company in an attempt to force his corporation to pay a large ransom, these villains found they worked well together as a team. Even though the heroes rescued the kidnap victim, the Smashers were so successful in beating the stuffings out of them in the process that they decided to stay together.

**Revenge:** Revenge-motivated groups are composed of villains who feel that they were wronged in some way, and have banded together to take revenge against a common enemy. One of the most popular themes in comic book literature concerns those villains who have been defeated by certain superheroes getting together to end the careers of their nemeses once and for all. Although these villains can be formidable to deal with, it should be noted that they will be familiar to the heroes so characters will have a good idea of how powerful the opposition is. Referees, on the other hand, get a break because they don't need to worry about coming up with a new supervillain for a while. In my own campaign, Terminator often recruited help from the ranks of the vengeful.

A small supervillain group may fit under several of the above classifications at once. None of the above categories excludes any other one from a group's development. The Academy of Supervillains, for one, is a prime example from my campaign. First founded by the Mind Worm, this set of neophytes was pitted against the superheroes as the Mind Worm attempted to train villainy for his own ends (superleader). When the Mind Worm died at the hands of the superheroes, his students stayed together (fraternal), hoping to avenge the death of their teacher (revenge) while endeavoring to support themselves by their criminal abilities (personal gain).

"Large" groups, as stated before, are subservient to their income. How much they make per week helps to determine their goals, personnel, and equipment. There will occasionally be those groups that do not rely upon an accountable income, such as invaders from space and the like: these, however, are the exceptions that prove the rule.

Listed below are some classifications of the weekly incomes of large criminal groups built along these lines. These groups will have their membership, equipment, and aims determined by their income. It is fair to assume that for every \$150 per week the group takes in, a non-super character (thug, hit man,

etc.) will be hired by the group and armed with common weaponry (pistols, knives, etc.). This assumes that there has already been an initial investment in forming the group, that the gang's personnel have enough funds to provide their own upkeep, and that the \$150 provides for funds incurred in the line of duty only.

For non-super personnel armed with "super" weaponry (laser pistols, anti-grav bikes, and other such equipment



not commonly available to the populace at large), assume \$750 per week per person so equipped. Equipment of this nature is not available to any group earning less than \$75,000 per week.

**Below \$2,000 per week:** Such groups are only small-time operations. They will not be well armed, have no superpowered individuals in their ranks, and confine their activities to muggings, theft, and other "small" crimes. They are included here because such individuals may be hired by rich supervillains in order to help out on a crime, whether to do some legwork or to soften up a superhero before they deal with him themselves. "Rookie" superheroes may have to deal with such villains early in their careers as well. Such groups are usually your typical street gang or motorcycle gang.

**\$2,000 to \$10,000 per week:** This group is a small-scale syndicate that may run numbers or vice operations and the like in a section of a major city. Their leadership is fairly secure, and often such groups are well entrenched in the community. This gives them some immunity from law-enforcement agencies and other civic groups, although a concentrated effort on the part of a group of superheroes would easily put the group out of business, for a while at least. The membership of such groups will be well armed with common weaponry. If a

superhero continually bothers the racket, operations may be curtailed for a while as funds are marshalled for a supervillain to be hired to handle the group's "problem."

**\$10,000 to \$100,000 per week:** This group carries over many of the trappings from the above group. Such a group will have the run of entire cities, even several of them, and will have a very well rooted leadership. Arming this group is conducted much like arming a

smaller one. Some groups in this earnings range (\$75,000 per week and over) will curtail their operations to have a few superpowered hit men hired to "take out" lawful opposition. These hit men are villains paid a commission per job performed.

Probably the best such hit man in the business in my game world is Simulacrum, a transforming villain who works freelance. He prefers being hired by larger groups, as they can pay him more than smaller organizations for his services. His rates are a bit high, but there are a number of individuals who plague the different rackets that make his fee for putting someone on ice seem like a bargain.

**\$100,000 to \$1,000,000 per week:** An ultra-powerful group, this is a potent force that attempts to control whole sectors of society for its own gain. A group like this works in the shadows for the most part, garnishing vast amounts of funds from well-respected, rich institutions like major corporations, as well as from many dirty sources. These groups will have many members, and may even have a few supervillains who work for a regular commission.

The leadership of such groups is often hard to track down, as the trail to the top will be well hidden. Direct confrontation with the leaders will be difficult at best; often they are of great power

(though not necessarily superpowered), and their personal defenses will be very tough.

**Over \$1,000,000 per week:** The ultimate criminal groups, these organizations can harass superheroes for entire campaigns. Such groups typically wish only one thing: absolute power and dominion over everything they can grasp. They will also have great influence in the world, extending their tentacles into the highest positions of governments around the world if powerful enough.

These groups will have unlimited resources, and are able to hire anyone they want and arm them with anything. Such is their power that even a local branch office will be an almost impenetrable superfortress (to say nothing of the main headquarters building). Such groups will often have a standing legion of supervillains at their call. The leadership of these ultra-groups will be almost impossible to trace and extremely well protected globally.

An example of these most dreaded of evil groups is OPATSEG (Operatives Attaining Supreme Effectiveness Globally), a group perhaps as old as ancient civilization from my campaign. It has key personnel in the Eastern Bloc and on the boards of many Western corporations. The ties this group has to everything are so well hidden that the heroes in the campaign miss links to this group most of the time.

It should be noted here that villains in a "large" group will not always have their membership based upon their ability to hire people. Supervillains may join a group of almost any size because of personal reasons, such as loyalty to a particular leader, the fulfillment of a debt that must be paid in service, or even as the result of outright coercion. It is always possible for a supervillain to run such a group; the higher the group's income, the greater the likelihood that the group is headed by a superpowered individual. Although a small mob run by a supervillain is a rarity, a group with world-wide influence like OPATSEG will definitely have one at its head.

Such are the general traits of organized opposition to your supergroup, but this is far from the end. What is presented here is only an outline. Many combinations of the above principles can be formulated with a little thinking, and even some possibilities not dealt with here may be developed. A superhero's life is not easy — and referees can make it all the harder (and more fun!) ▲



# A World Gone Mad

*The Moon of the*  
**GAMMA WORLD®**

— *g a m e* —  
By **James M. Ward**

Eons before mankind existed, an asteroid slammed into the northern hemisphere of the Moon and formed the crater later known as Tycho. This particular asteroid had a very high metallic content and internal density. When humans scouted and explored the barren lunar surface, they found that Tycho Crater contained large amounts of high-grade ore that could be processed into the toughest and most durable metal known: Duralloy.

A major lunar base was built at Tycho Crater in A.D. 2014. Its original function was to mine the ore used to produce Duralloy; because of the base's importance, it was expanded from generation to generation until the base became the only human-inhabited outpost on the moon. The resources of the Earth's small satellite were not adequate to support a human population of greater than 50,000 people; Tycho soon had them all.

When Tycho Center became the only human-populated center on the Moon, all other lunar bases were completely automated and were crewed by robots and androids. These "outer bases" were controlled by the Cybernetic Installation at Tycho Center. Scattered across the Moon, these bases included astronomical observatories, crystal mines, water-processing plants, android and drug factories, and two heavy industrial manufacturing complexes.

All good things must come to an end. In A.D. 2322, the people stationed on the Moon watched Earth's civilization go down in war, plague, and a host of other disasters that followed the start of the

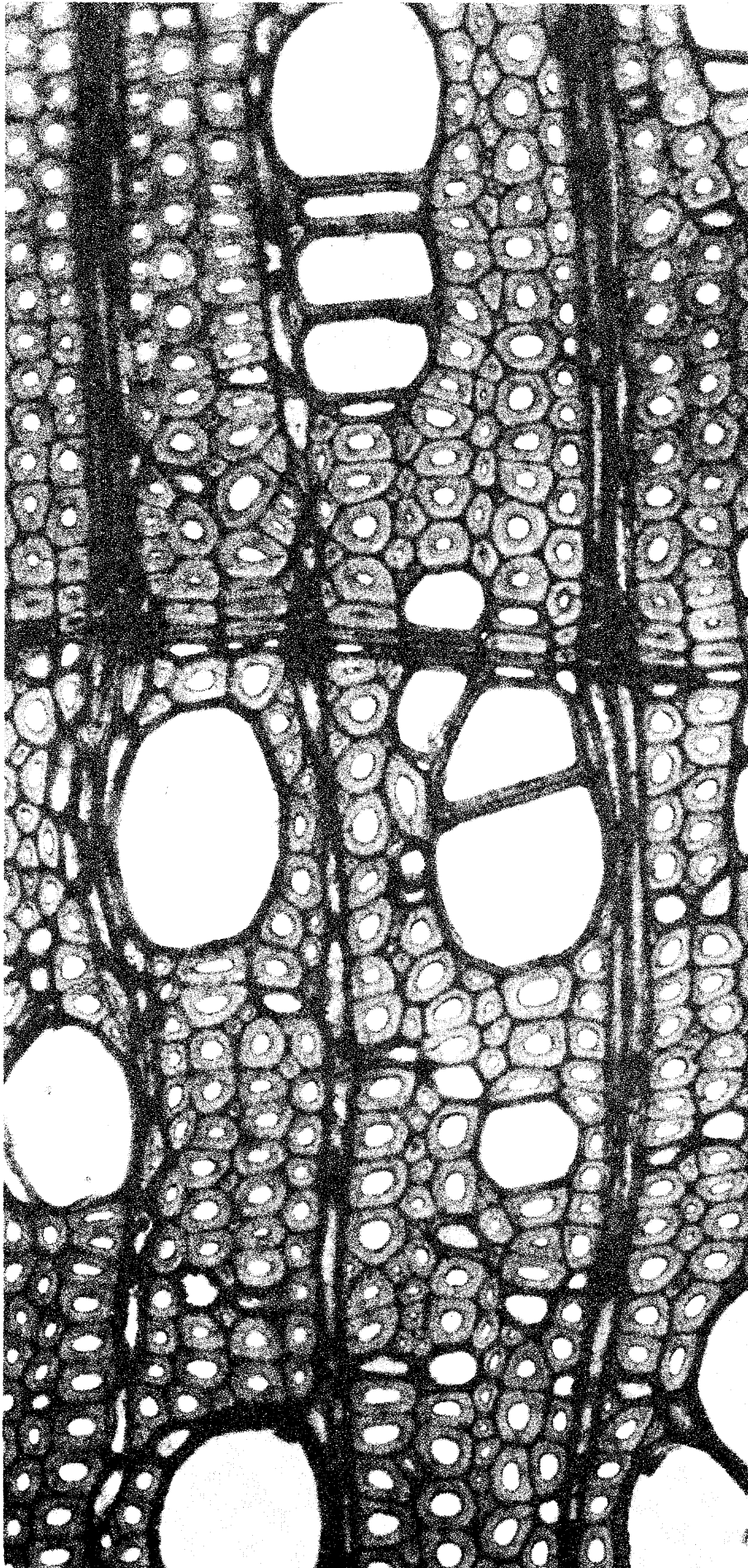

"Social Wars." Many colonists elected to go back to Earth to find loved ones or help those who might still be alive. Many more stayed behind, content with the Moon's relative security and fearful of what horrors might be found on their blasted and ruined homeworld.

Those who returned to Earth did so using a number of bubble cars assigned to Tycho Center's transportation section. Most of the fifty or so bubble cars that returned to Earth were never seen again. A few of them did make it back to Tycho Center, but they brought infected crews and passengers with them. Within hours, plague viruses were spread by the automatic ventilation system throughout Tycho Center. Long existence in a virtually germ-free artificial station had rendered the lunar colonists vulnerable to the slightest infection, and a host of diseases ravaged them.

Unable to escape in time, the 50,000 colonists died quickly. At last, only one human being was left alive at Tycho Center. His name was Ren Odinson, the colony's commander. Ren programmed the station's Cybernetic Installation to continue all normal operations in the event the station could be reinhabited; after putting the Tycho CI on continually-sustaining mode, he died in his command chair.

For the first fifty or so years after the Social Wars, the Tycho CI maintained almost everything at the station in perfect order while waiting for the humans to come back. Worn-out equipment was replaced from the engineering shops. Mining operations beneath Tycho Center continued and huge stockpiles of refined duralloy metal were set aside, ready for use. Normal observations were made on all the ongoing biological and chemical experiments that were started in the Center's laboratories before the wars.

Only two unusual (but major) events occurred: the horticultural growths of each and every hydroponics section were allowed to mutate unhindered, and many biological radiation experiments caused accelerated growth and mutation in various forms of single-celled creatures. These two events combined to create a strange and unending war for control of the main station computer.

By A.D. 2360, the irradiated plant life had gained full control over the environment of the hydroponics sections. Plants mutated into lifeforms that could destroy bothersome robots or manipulate the Tycho CI to generate more food and water for their root systems.

Operating from existing programs, the CI could do nothing about the destructive power of the plants. It was programmed to continue feeding and monitoring operations in those sections, and that is what it did.

The best the CI could do against the plants was to plow a single three-meter lane through every hydroponics area for the cargo and transportation robots to move through. This was accomplished at the cost of three horticultural robots ruined each month in plant-cutting operations. Replacement robots had to be manufactured from materials in Tycho Center's mining and manufacturing departments.

It was the same story in the biolabs. The huge, mutated (but still single-celled) creatures took over the labs and created environments in which they grew and prospered. New abilities enabled these bizarre creatures to work in the lab areas and many of them developed incredible talents. Where the mutated plants were aggressive by nature, the macrobes (huge microbes) developed defensive mutations that became nearly unstoppable. Engineering robots sent into the biolabs to clean up what were thought to be batches of debris were depowered by one type of single-celled macrobe and eaten by another.

Despite all this, the CI stuck to its programs and continued feeding the mutant macrobes. A three-meter wide lane through the macrobe colonies in the biolabs was kept open (just as in the horticultural areas) at the cost of nine heavy engineering robots ruined each month in the operations.

From about A.D. 2360 to 2400, various plants and single-celled macrobes left their "home" sections and spread slowly throughout Tycho Center. Colonies of mutated life entered and settled down in newly discovered chambers and crawl spaces wherever they could be found. The inevitable happened around the year 2400, when the two expanding biosystems came into immediate contact with each other. Each somehow recognized that the other was competing not only for living space, but for control of the Tycho CI's bio-programming. It was unspoken war from then on.

The plant and macrobe forces devoted all of their resources in the fight against each other. Whole new lifeforms were created and wiped out in the battles between plant and giant bacteria. Vast sections of Tycho Center were burned out and destroyed in the fighting, and the lethal vacuum of space filled entire

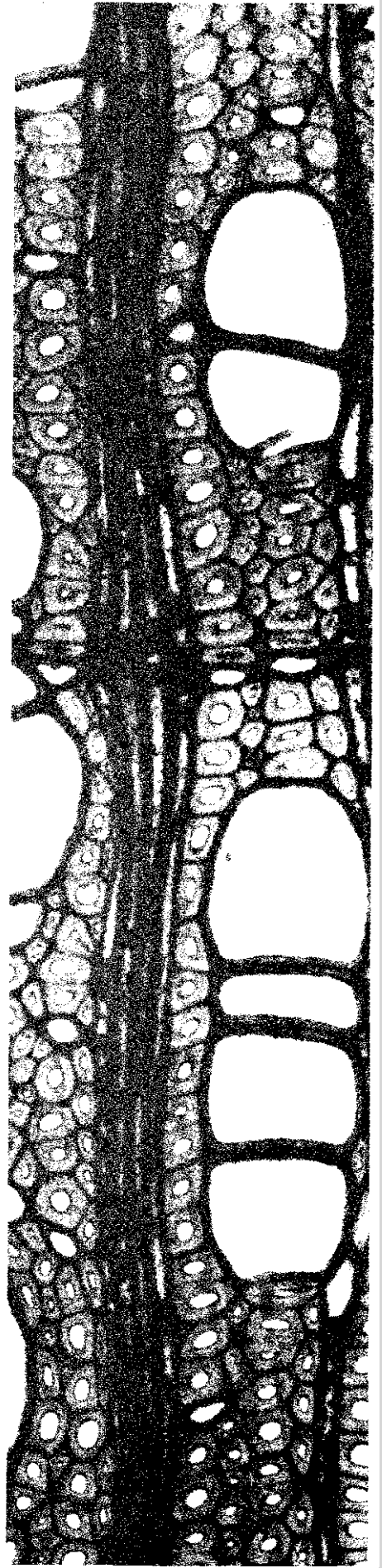

areas near the surface of the complex and destroyed the combatants.

The severely damaged sections of Tycho Center were fixed by engineering and repair robots controlled by the Tycho CI. It knew what was happening in the plant-macrobe war, but it only allowed itself to take steps to ensure its own survival. Its programming would not take the nature of the mutant plants and bacteria into consideration to destroy them.

The unmanned "outer bases" around the Moon continued to operate after the Social Wars. The operations of all industrial factories were turned to the manufacture of spare parts for Tycho Center as it began replacing its damaged sections when the plant-bacteria wars began. The other bases continued their routine functions, generally unmanaged by the Tycho CI which had other things to worry about. Several times over the years Earth-bound CIs and Think Tanks were able to contact and communicate

ride of their lives. One by one, the cars landed at Tycho Center; the Tycho CI, gratified to have visitors at last, automatically brought the cars into the base proper, pressurized the docking facility, and opened the main doors into the Center.

For the first time in over 100 years, intelligent beings walked the halls of the base. They looked in upon a world gone mad.

### **Adventuring at Tycho Center**

Setting up an adventure at Tycho Center may appear intimidating, but it need not be. The entire base does not need to be drawn out; the referee can exclude some sections if desired and fully draw out others.

Because of its size, a general layout of Tycho Center is not shown with this article; the referee is free to design his own base (think of it as an extra-large "dungeon"). Tycho Center consists of a

the engineering section to make more robots. Note that the housing centers were designed to support 50,000 people, and it might be easier to have most of these areas be overrun by mutant plants and macrobes to discourage PCs from investigating them thoroughly. The command center for the colony is in one of the housing centers, however, and may prove to be a valuable prize.

The atmosphere inside Tycho Center is very stale but quite breathable. Artificial gravity generators are set throughout the station, so the characters will not have to worry about hopping about in one-sixth normal gravity (unless they go outside). The viruses that killed off the population of Tycho Center have since died off themselves, and present no danger whatsoever to characters (though they won't know that at first).

The Tycho CI will accept programming and will communicate with any pure-strain human, mutant humanoid, or mutant animal; the computer has taken orders from plants and macrobes for so long that it no longer makes distinctions about who is programming it.

The CI will happily provide anyone with information on the station's current situation, but it will know little or nothing about sections of the station that have been sealed off. It may also know very little about the deep interiors of the plant and macrobe "homelands" except for the 3-meter wide highways it plows through them.

Tycho Center may serve as the focal point for a long, "high-level" GAMMA WORLD game campaign. The Center is full of Ancient artifacts, including vast quantities of processed duralloy, but transporting the material back to Earth may prove to be a terrible problem. Remember that if the PCs got to the Moon as one of the Cryptic Alliance teams (or as an independent force), other bubble cars will be showing up soon (or are already there).

The mutants at the Center must also be dealt with. The referee should have a field day designing other mutant monsters to horrify and torment lucky PCs, though some appropriately pleasant rewards might be discovered as well.

Between the wild mutant plants, giant bacteria, and hostile (and heavily-armed) Cryptic Alliances charging around the base, player characters should find the Moon of the future quite amusing. It certainly isn't Kansas, Toto.

*Look for a list of mutant macrobes and plants that adventurers might encounter at Tycho Center, in the next issue.* ▲

## **Tycho Center may serve as the focal point for a long, "high-level" GAMMA WORLD game campaign. The Center is full of Ancient artifacts, including vast quantities of processed duralloy.**

with other lunar bases and even with the Tycho CI, but such contact was sporadic and unpredictable at best, and little came of it.

This was the picture in A.D. 2452 when several Cryptic Alliance groups were independently able to figure out the workings of some abandoned bubble cars they had discovered. Some of the vehicles had been pre-programmed to return to the Moon and Tycho Center; the Cryptic Alliances either missed the programs or decided to use them and visit the lunar station in hopes of gaining access to more powerful technology and knowledge. By strange coincidence, each Alliance launched its expedition to the Moon within the same three-day period.

Whether they went knowingly or as the prisoners of the bubble cars' guidance systems, the passengers on the half-dozen bubble cars were in for the

surface landing area with underground docking facilities, a surface storage area, the computer complex for the Tycho CI, an underground storage area, two hydroponics labs (both infested with mutant plants), two biological laboratories (infested with macrobes), a nuclear power plant, an engineering and repair center that now houses most of the robot manufacturing equipment and spare parts, and several small housing centers and business zones for the human colonists. Three mining zones branch away from Tycho Center, each worked continually by robots and avoided by the plants and macrobes. Some sections may have been sealed off by the plant-macrobe war or by computer error.

The duralloy produced from the mines is stored in the underground storage area, and it is eventually used in

# FURIOUS ACTION

On the final frontier. The best ships and the finest crews go toe to toe at the edge of the universe. A unique team play system puts you on the bridge of the legendary *Enterprise* in



# STAR TREK® II

## STARSHIP COMBAT GAME

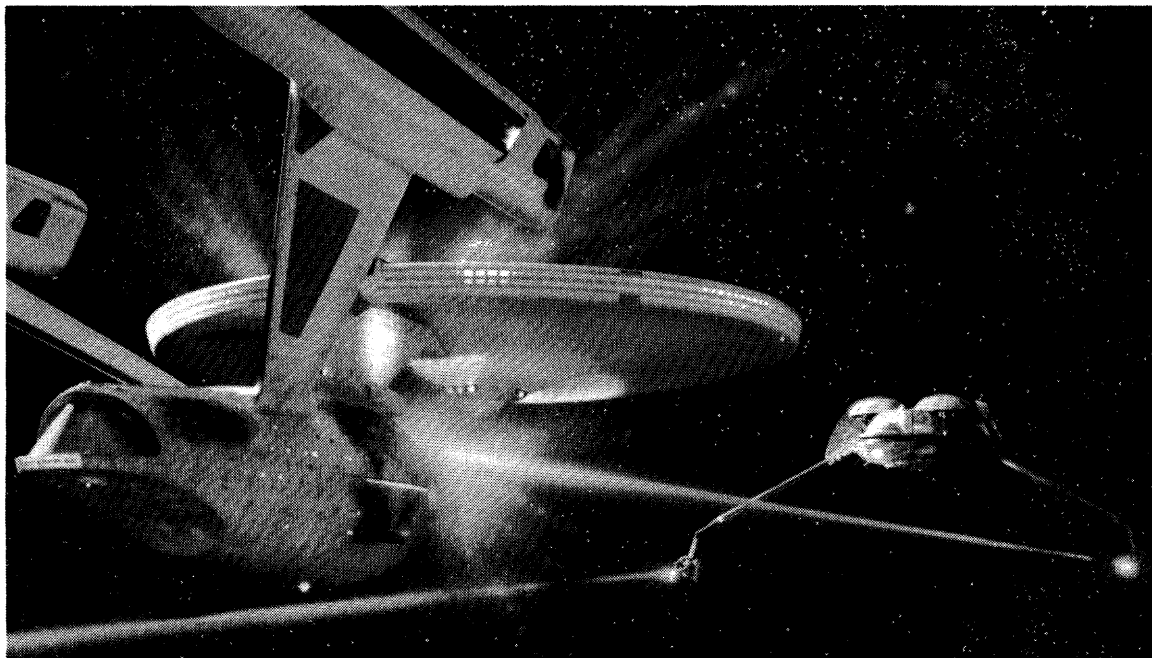

### ARKANSAS

House of Hobbies -  
3408 South University  
Little Rock, AR 72204  
(501) 562-8230

### CALIFORNIA

Game Towne  
3854 Harney Street  
Old Towne  
San Diego, CA 92110  
(619) 291-1666

Our Store  
5011 York Blvd.  
Los Angeles, CA 90042  
(213) 256-3577

### FLORIDA

Enterprise 1701  
1206 E. Colonial Dr.  
Orlando, FL 32803  
(305) 896-1701

Gandee Toys  
965 E. Memorial Blvd.  
Lakeland, FL 33801  
(813) 683-3480

### ILLINOIS

Beyer's Hobby Shop  
236 Main Street  
Woodstock, IL 60098  
(815) 338-1640

Friend's Hobby Shop  
1413 Washington St.  
Waukegan, IL 60085  
(312) 577-9866

Games Plus  
20 West Busse Avenue  
Mt. Prospect, IL 60056  
(312) 577-9866

Mini-Mall Hobbies  
Mini-Mall Shopping Ctr.  
3669 Nameoki Rd.  
Granite City, IL 62040  
(618) 877-8099

### INDIANA

Wizards Keep  
1610 W. University  
Muncie, IN 47306  
(317) 288-1508

### IOWA

Fantasy Game Shop  
2306 University  
Des Moines, IA 50311  
(515) 274-2521

### KANSAS

Comics & Fantasys  
1402 West 17th Street  
Topeka, KS 66604  
(913) 232-3429

King's Crown  
6860 West 106th Street  
Metcalf Shopping Center  
Overland Park, KS 66212  
(913) 341-6619

### MICHIGAN

Red Dragon  
230 N. State St.  
Devision, MI 48423  
(313) 233-7672

### MISSOURI

Dragon's Lair  
5 South Old Orchard  
St. Louis, MO 63119  
(314) 968-3360

Parallel Worlds  
12th & Virginia  
Joplin Flea Market  
Joplin, MO 64801

Yankee Doodle Game  
& Hobby  
6831 Longview Road  
Kansas City, MO 64134  
(816) 761-1113

### NEVADA

Page After Page Comics  
1236 E. Charleston Blvd.  
Las Vegas, NV 89104  
(702) 384-1690

### NEW JERSEY

Game Master Ltd.  
Village Mall (Lower Level)  
Bergen Mall Shpg. Ctr.  
Paramus, NJ 07742  
(201) 843-3308

Hobby Shop of Matawan  
Route 34  
Strathmore Shopping Center  
Matawan, NJ 07747  
(201) 583-0606

### NEW MEXICO

Archaic Hobbies  
600 E. Montana Suite A  
Las Cruces, NM 88001  
(505) 522-2336

### NEW YORK

Adventure Games &  
Hobbies  
714 Terrace  
Depew, NY 14043  
(716) 686-3131

Campaign Hq.  
296 Driving Park Ave.  
Rochester, NY 14613  
(716) 254-5897

Hobby Hut  
2835 Nostrand Ave.  
Brooklyn, NY 11229  
(212) 338-2564

Quest's End  
220 The Commons  
Ithaca, NY 14850  
(607) 272-5186

### NORTH CAROLINA

Dragon's Nest  
101 Eastway Drive  
North Park Mall  
Charlotte, NC 28213  
(704) 596-9466

Newsstand International  
Providence Sq. Shpg. Ctr.  
Charlotte, NC 28211  
(704) 366-9466

### OHIO

Drowsy Dragon  
34 Maplewood Avenue  
Columbus, OH 43213  
(614) 231-8634

Hall's Hobbies  
3150 South Hamilton  
Columbus, OH 43277  
(614) 864-6464

### OREGON

Military Corner  
2725 N.E. Broadway  
Portland, OR 97232  
(503) 287-6068

### SOUTH CAROLINA

Green Dragon  
Charles Town Square Mall  
N. Charleston, SC 29405  
(803) 744-8783

### SOUTH DAKOTA

Fun & Games Store  
28th & Minnesota  
Sioux Falls, SD 57105  
(605) 336-0444

### TEXAS

Book Stan  
542 9th Avenue  
Port Arthur, TX 77642  
(409) 983-5007

Fantastic Worlds  
Book Store  
3011 Lackland Road  
Fort Worth, TX 76116  
(817) 731-6222

### VIRGINIA

Wargamer's Hobby Shop  
200 Leesburg Pike (Rte. 7)  
Sterling Park, VA 22170  
(703) 450-6738

### WASHINGTON

Merlyn's  
West 621 Mallon  
Spokane, WA 99201  
(509) 325-9114

STAR TREK is a trademark of Paramount Pictures Corporation.  
STAR TREK II: The Search For Spock products are published by FASA Corporation  
under exclusive license from Paramount Pictures Corporation, the trademark owner.

DEALERS: If you wish to be  
included in future listings, contact:

**Hobby Game Distributors, Inc.**  
6611 N. Lincoln Ave.  
Lincolnwood, IL 60645  
(312) 674-5075 (In Illinois)  
(800) 621-6419 (Outside Illinois)







# Fast and Deadly

*New starships for the  
STAR FRONTIERS® Knight Hawks game*

by Carl Smith

Viyizzi the Yazirian blinked and adjusted the rangefinder. A blip had appeared on the scanner where nothing could be seen before. Keeping her eyes on it, she called Captain Llewellyn.

"Bogie closing," she said, omitting the "sir" as usual.

Llewellyn left his command chair and moved over to her station. "Is it a Sathar?"

Viyizzi squinted and fiddled with her goggles. "Hard to say. Seems a little small for one." She ran up the magnification in hopes of making an identification, but shrugged.

"That only leaves UPF vessels," Llewellyn remarked. "Can we outrun it?"

"If we don't outrun it, *Lightspeed Lady* gets sold at auction, and we do time for blockade running over corporate lines." Viyizzi bit her lip. "Whatever we're going to do, let's do it now."

Llewellyn nodded grimly. "Let's go, then. *Lightspeed Lady* is a lover, not a fighter — unless we get cornered." Going back to his grav-couch, he punched a few buttons on the console before him.

Engines firing at full speed, *Lightspeed Lady* soon left the closing vessel far behind and vanished into space.

The UPF frigate searched the area around the planet for twenty minutes before giving up the hunt for the *Lady*. The captain sighed, recorded the incident, and gave orders to resume the ship's regular patrol patterns. Once more a privateer had managed to run the blockade at Theseus.

New starships will be available on June 1st, 1984, for all gamers who use the STAR FRONTIERS® Knight Hawks game system. The ship miniatures will include yachts and privateers for interstellar businessmen, adventurers, and pirates to use for transportation and space warfare.

Interstellar yachts include commercial vessels as large as liners, as well as smaller, privately owned craft that corporations and wealthy citizens might use. Privateers are privately owned vessels outfitted as protective escorts for company freighters, as government-supported raiders which prey on enemy commerce or Sathar vessels, or as pirate ships that prey on anyone and everyone.

## Yachts

The six types of interstellar yachts vary in size. Some are as big as light cruisers while others are only marginally larger than assault scouts. Each yacht listed below is representative of an entire class of yachts, and is described with all relevant game statistics. Abbreviations are used for hull size (HS), hull points (HP), acceleration/deceleration factor (ADF), maneuver rating (MR), and damage control rating (DCR).

*Belvedere Class* — HS 9, HP 45, ADF 2, MR 3, DCR 47; Weapons: laser battery, 1 laser cannon; Defenses: reflective hull; one lifeboat.

*Astro-Blaster III Class* — HS 6, HP 30, ADF 1, MR 2, DCR 38; Weapons: electron beam battery; Defenses: reflective hull, interceptor missile battery; no lifeboats.

*Imp Class* — HS 4, HP 20, ADF 4, MR 3, DCR 32; Weapons: laser battery; Defenses: reflective hull; no lifeboats.

*Nova Class* — HS 5, HP 25, ADF 2, MR 2, DCR 35; Weapons: laser battery, 3 assault rocket batteries; Defenses: reflective hull; no lifeboats.

*Rim-Song Class* — HS 3, HP 15, ADF 4, MR 3, DCR 29; Weapons: laser battery, assault rocket battery; Defenses: reflective hull; no lifeboats.

*Nebula Class* — HS 7, HP 35, ADF 2, MR 2, DCR 41; Weapons: laser battery, 2 assault rocket batteries; Defenses: reflective hull, masking screen; one lifeboat.

## Privateers

Privateers are privately owned or corporate vessels especially outfitted for one job — fighting! Privateers are usually yachts, freighters or obsolete military vessels which have been re-armed and upgraded. They vary in size from that of an assault scout to ships almost as large as a cruiser.

Privateers hunt down pirates, protect corporation vessels from Sathar and

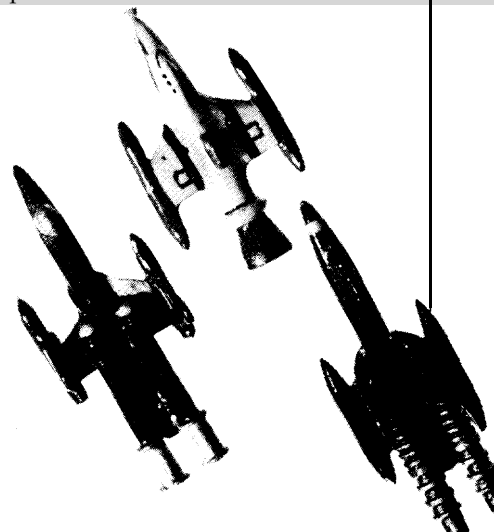

other enemy ships, and sometimes act as pirate ships themselves. They can be armed in many different ways. If you wish to alter the ship statistics given below, consult the rules laid out in the STAR FRONTIERS® Knight Hawks games when creating your variant ship. Each vessel below is representative of an entire class of ships.

**Rollo's Revenge** — HS 10, HP 50, ADF 3, MR 2, DCR 50; Weapons: laser battery, proton beam battery, 2 electron beam batteries, 4 torpedoes; Defenses: reflective hull, masking screen, 3 interceptor missile batteries; 1 lifeboat.

**Condor Class** — HS 13, HP 65, ADF 3, MR 3, DCR 59; Weapons: disruptor beam cannon, 2 laser batteries, proton beam battery, electron beam battery, 3 torpedoes; Defenses: reflective hull, electron screen, proton screen, masking screen, 2 interceptor missile batteries; 1 lifeboat.

**Moonbright Stinger Class** — HS 9, HP 45, ADF 3, MR 2, DCR 45; Weapons: laser cannon, 2 seeker missile batteries, electron beam battery, 2 torpedoes; Defenses: reflective hull, masking screen, interceptor missile battery; 1 lifeboat.

**Thruster Class** — HS 2, HP 10, ADF 4, MR 4, DCR 26; Weapons: laser cannon, 2 assault rocket batteries; Defenses: reflective hull; no lifeboats.

**Lightspeed Lady Class** — HS 4, HP 20, ADF 4, MR 3, DCR 32; Weapons: laser battery, 3 assault rocket batteries; Defenses: reflective hull, masking screen; no lifeboats.

**Golden Vanity Class** — HS 4, HP 20, ADF 3, MR 4, DCR 32; Weapons: 3 laser batteries, 2 assault rocket batteries; Defenses: reflective hull, masking screen; no lifeboats.

## New Scenarios

### I. Incident 47-Q — Attempted piracy

The Belvedere-class yacht *Gaston*, out of Fromeltar, was carrying supplies bound for K'aken-Kar. Entering the Kizk-Kar system, the *Gaston* was approached by two vessels. Bo'kan Yorb, the Yazirian captain of the *Gaston*, demanded that the vessels identify themselves; no word came back but the starships opened fire moments later from 50,000 km. The attackers were identified as Moonbright Stinger-class pirates.

Captain Yorb sent an S.O.S. to all UPF vessels in the area, then managed to destroy one vessel (*Darkstar Warrior*) and severely damage the other (which

fled after taking damage). When last seen, the surviving ship (*Midnight Wasp*) was headed in the direction of Madderly's Star. A pirate base is generally believed to be in that area but has not been located as of this date.

**Set up:** The *Gaston* begins the game 5 hexes (50,000 km) away from the two other vessels. The two pirates should appear at the 4 o'clock position with regards to the *Gaston*. All ships are fully armed; the pirates fire first. The *Gaston* has an initial speed of 2; the pirates start at a speed of 3.

**Victory conditions:** The *Gaston* must avoid taking over 35 hull points damage, or else will surrender. Each pirate will fight until it takes 25 hull points damage, at which time it will attempt to flee. The pirates must stop firing once the *Gaston* surrenders; the *Gaston* may continue firing at all targets until it surrenders.

### II. Incident 114-T — Interception of blockade runner

A Dauntless-class assault scout, the UPFS *Devastator*, was on routine patrol around Theseus when it intercepted an unknown starship attempting to enter the Theseus system. Approaching the vessel as it was 70,000 km from the planet Minotaur, the captain demanded that the vessel identify itself as "distressed" or leave the restricted area under escort.

The vessel, later identified as the *Lightspeed Lady* (of the same class of yachts), took evasive action and headed planet-side. The vessel was intercepted on the *Devastator's* 10 o'clock position. The blockade runner evidently sighted the UPF vessel closing in a 2 o'clock position and opted to escape. After a running battle, the UPFS *Devastator* ran into some asteroidal debris, took moderate damage to her guidance system, and allowed the *Lightspeed Lady* to escape. Rumors support the theory that the *Lightspeed Lady* was transporting illegal armaments to residents of Theseus and did not complete its mission.

**Set up:** The ships may be set up as described above and begin the game 7 hexes apart. Minotaur lies 10 hexes directly ahead of the *Lightspeed Lady* at the game's start. The *Devastator's* statistics are common to all UPF assault scouts. The privateer has an initial speed of 3; the UPF vessel travels at 4.

**Victory Conditions:** The *Lightspeed Lady* wins if it can get 10 or more hexes away from the UPF scout. The scout wins if it can inflict 12 or more hull points damage on the privateer, which will force it to surrender.

### III. Incident 329-J — Raid on commercial vessel

The Nebula-class yacht *Ch't'kl*, commanded by Captain Vliik Klik'k, a Vrusk, was heading into the Scree Fon system from Dixon's Star when it was intercepted by two Sathar fighters from the assault carrier SAV *Deathknight*. The *Deathknight* was operating on a deep penetration mission into that frontier area. The fighters closed from a distance of 80,000 km, having been screened by a minor asteroid while waiting for the yacht.

The two fighters (*Horror* and *Fear*) closed from *Ch't'kl's* 10 o'clock position and raked the vessel with rockets. The *Ch't'kl* sent out a distress call and received a faint reply from a distant UPF assault scout. The ensuing battle lasted less than an hour's time. The UPF assault scout arrived only to find the shattered and sundered hulk of the *Ch't'kl*. Tapes recovered from her hull reveal that she severely damaged one fighter and traded shots with the other until a "lucky" shot destroyed her propulsion system and sent her into an asteroid.

**Set up:** The *Ch't'kl* begins the game with an asteroid set 8 hexes to its 10 o'clock position, moving at a speed of 2. The two Sathar craft begin at a speed of 0 (zero), in the same hex as the asteroid (they were only 500 km behind it).

**Victory conditions:** The Sathar win if they manage to disable the *Ch't'kl* by inflicting at least 30 HP damage on it, at which point the *Ch't'kl* will surrender. The *Ch't'kl* wins if it can put 15 hexes distance between it and the Sathar craft, or if it can destroy or disable the Sathar.

## Creating new scenarios

New scenarios may be easily developed for the STAR FRONTIERS Knight Hawks game, using some of the above situations as guidelines. The forces in a game should be evenly matched, though (as may be seen above) they don't have to be set up that way. More experienced or daring players may decide to pit a reduced force against a more powerful attacker or defender managed by one or more less experienced opponents.

It should be noted that during both the First and Second Sathar Wars, neither side massed starship forces larger than ten or so ships per side in a single battle. Of course, there's nothing to keep players from setting up titanic battles with twenty or more ships per side, and with two or more players per team each controlling part of a fleet. Let your imagination run free, and enjoy the new Knight Hawks miniatures.

# Interstellar Athletes

A TRAVELLER® game variant career

by Michael Brown

Competitive sports are a way of life on many worlds in the inhabited galaxy of the future, and athletics are usually an integral part of many societies. But what of the participants of such activities? How do athletes fit into the larger life of interstellar travelers? This unofficial character career may help gamers answer that question. One would suppose that athletes often retire rich and famous in galactic empires, just as they do on Earth, A.D. 1984; at the very least, they may end their careers in very good shape.

The athlete class is detailed here, with a few sports commonly played within the Imperium described afterwards. Character generation and progression is performed as per the usual TRAVELLER game rules, using the tables below.

## Athlete Prior Service Tables

The prior service of an athlete character is determined in exactly the same manner as is any other TRAVELLER® game career, as outlined in Book 1, *Characters and Combat*, with the substitution of the following tables. Athletes begin their careers at age 18, and advance in four-year terms like regular characters.

Enlistment: 5+

DM of +1 if STR 8+

DM of +2 of DEX 10+

Survival: 3+ (see below, however)

DM of +1 if INT 9+

Re-enlist: 5+

Aging: Athletes may ignore the aging roll for the fourth term of enlistment. They gain a DM (die modifier) of +2 for the fifth-term roll and a DM of +1 for the sixth term, but make all subsequent rolls normally.

## Skills

Athletes gain an automatic skill of Sport-1 when first enlisting in this career.

Thereafter, they may roll two skills on the Acquired Skills Table for their first term of enlistment, and one skill for each term served afterwards.

New Skill: *Sport*. Sport is a general term for any type of known sporting event. The referee and player should confer as to what type of sport was formerly played by the athlete, according to the character's ability scores and the player's whim. The athlete may or may not have DMs in activities related to his or her particular sport. A rating of Sport-3, or Sport-2 and Instruction-1, is sufficient to be able to coach teams in that sporting event. The exact benefits gained from a Sport skill should be determined by the DM, but the possibilities of fame, increased chances of winning sporting events, and in winning money should not be overlooked.

## Mustering Out

Once an athlete fails to make a reenlistment roll or decides to leave his career (which can be done at the conclusion of any four-year term), he musters out by

rolling once on either the Material Benefits or the Cash Benefits Tables below. A +1 DM is applied to the Material Benefits roll if the character's SOC is A+; A +1 DM is given on the Cash Benefits roll if the character has any gambling skill. The Cash table can only be consulted three times at most.

## Sports of the Future

**Z-G (Zero-Gee) Ball:** An anti-grav sport played on worlds of tech level B+. It consists of two four-man teams in light plastic armor, a four-kilogram steel ball, and an enclosed null-grav court. Gravball players must have a dexterity of 10+. Gravball skill allows a DM of +1 for every two skill levels of the sport when engaging in zero-G combat.

**Slaughtersphere:** A more violent form of Z-G ball which uses a ten-kilogram steel ball. Slaughtersphere is illegal in most areas, and private enterprises are often the only sponsors of such teams. Slaughtersphere players have the same requirements as gravball players, except for a strength requirement of 8+. They gain the same zero-G combat benefits as Z-G ball players. The survival roll is 5+.

**Lightracquet:** A racquetball-like sport played on worlds of tech level D+. The ball is replaced by a holographic image and light trail. The racquet is a light sensor/refractor that sends the hologram ball off in the desired direction. The walls perform the same functions as the racquet.

Table One: Acquired Skills

Die	Personal Development	Service Skills	Advanced Education	Advanced Education (+8 EDU only)
1	+2 STR	brawling	streetwise	medical
2	+2 DEX	blade cbt	bribery	electronic
3	+2 END	sport	jack-o-T	sport
4	carousing	vehicle	gambling	+1 INT
5	+1 INT	sport	sport	instructor
6	+1 SOC	sport	mechanical	computer

Table Two: Benefits

Die	Material	Cash
1	low psg	2,000
2	mid psg	5,000
3	vehicle	10,000
4	weapon	25,000
5	+1 STR	50,000
6	+1 INT	70,000
7	Travellers'	100,000

# A NEW STARFIRE

Coming this month

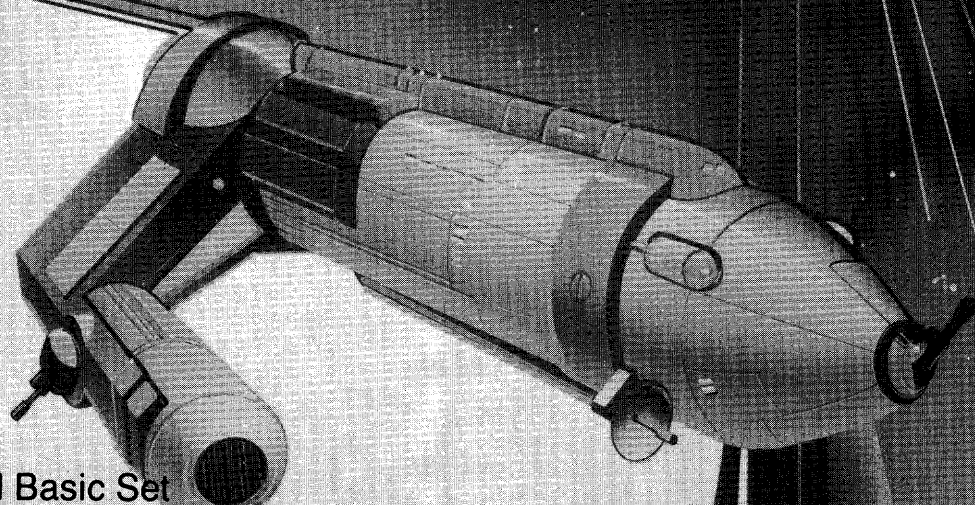

- ★ **New Boxed Basic Set**  
*Reworked rules for starships and fighters*  
(#1031 STARFIRE — \$12.95)
- ★ **New Modules**  
(#1032 NEW EMPIRES — \$7.95; #1033 THE GORM-KHANATE WAR — \$6.95)
- ★ **New STARFIRE Miniatures** — *Playing pieces for STARFIRE*  
(#1510 through 1517 — \$3.95 per package)

**TASK FORCE GAMES**  
The NEW FORCE in gaming.



## Rumors abound in the Imperium that various types of psionic sports are played on the more permissive worlds. Of course, if such sports exist they would be quite illegal.

**Gladiatorials:** Highly illegal on some worlds, gladiatorial combat is a way of life on others, particularly on low-tech worlds. High-tech worlds that allow gladiatorials sometimes pit men not only against other men or animals but also against robots. Robot-versus-robot combat is also popular on many worlds, the contestants remotely controlled by the players. A skill level in a gladiatorial sport is equivalent to a weapons combat skill, either brawling or a specified gun or blade weapon. The survival roll for this "sport" is 6+.

**Magnaball:** Magnaball consists of an enclosed, magnetic-flux court (some varieties allow for the use of an outdoor court), padded uniforms for the players, and a two-kilogram steel sphere. Gauntlets are provided which can control magnetic fluxes sufficiently to attract or

repel the ball, and the court can generate random magnetic "bottles" to alter its flight. Magnaball is played on worlds of tech level 9+. Players must have a dexterity of 8+ and an endurance of 9+.

**Hyperball:** A variant of magnaball played on worlds of tech level D+. Hyperball equipment differs from that used in magnaball; a set of plastic body armor with reflex-enhancing bionic relays, effectively doubling one's speed as though they were taking slow drug, is worn by all players. Hyperball players must have an endurance of A+ and a strength of 8+.

Other sports can easily be used or created, such as existing games, futuristic versions of these games, or even hybrid games. A couple of interesting suggestions would be futuristic versions of football, skeet shooting, and racing.

Games seen on TV, in the movies, or in books could be adapted and used (notably FASA's GRAV-BALL™ game, or the famed "Rollerball" sport created by William Harrison).

The guide to what sport the character played (or plays) should be the personal statistics of that character. For instance, a character with a UPP of B59259 could possibly have been a heavy-weight boxer, a wrestler, a gladiator, or anything else which calls for great strength and endurance. If a character seems tall, thin, and nimble, he could have been a basketball or Z-G ball player, and so on.

Rumors abound in the Imperium that various types of psionic sports are played on the more permissive worlds. Of course, if such sports exist they would be quite illegal and only privately endorsed.

A

## Put yourself in the story!

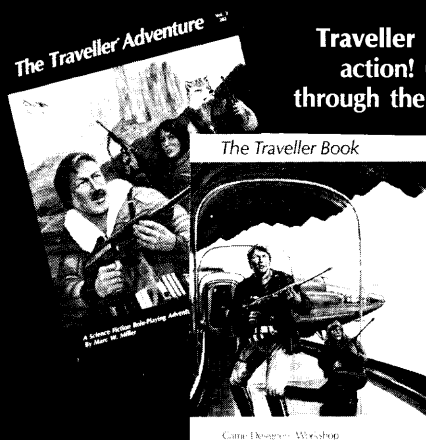

Traveller puts you in the middle of the action! Guide your favorite character through the mysteries and dangers of the far future. Explore alien worlds, puzzle out the enigmas of ancient civilizations, conduct complicated confidence scams, smuggle, build empires, lead revolutions, wage interstellar war . . . the list of science fiction role-playing adventures is as unlimited as your own imagination.

## TRAVELLER

Science-Fiction Adventure®  
in the Far Future

### The Traveller Book

Complete rules, background, advice for players and referees, scenarios, and two short adventures.

### The Traveller Adventure

A series of interwoven scenarios and adventures among the worlds of the Spinward Marches. There are more than forty books, boxed sets, modules, supplements, adventures, and games for Traveller, with new material appearing regularly. Traveller is available from better book, game, and hobby retailers around the world.



## Game Designers' Workshop

P.O. Box 1646, Bloomington, Illinois 61702  
Free Catalog on Request

# StarQuestions

Questions, answers, and advice on GAMMA WORLD® gaming

by James M. Ward

This edition of StarQuestions looks at the GAMMA WORLD® game. Some of the questions and answers used here were generated for POLYHEDRON™ Newszine and appear here with permission of the editor of POLYHEDRON Newszine.

Q: Can cyborgs be influenced by mutational attacks?

A: Cyborgs have organic brains, which can be influenced by most attacks that would work on flesh-and-blood enemies. *Mental Blast*, for example, is effective against cyborg brains. Referees may use scores of 18 for mental strength and intelligence for cyborgs, Think Tanks, etc. Similarly, a *Life Leech* attack will effect the brain of the cyborg just as it would another living being. Use scores of 12 in all relevant categories, like Constitution, for cyborg brains. Note that some mutations, like *Allurement*, would not work against cyborgs, as they depend upon the victims having a sense of smell, etc. Other mutations, like *Actual Metamorphosis*, would require touching the cyborg brain itself (which is not possible with most cyborgs).

Q: Why do the characters have to try and figure out things? It should be obvious to any being how a gun or similar high-tech item works.

A: It shouldn't be obvious how things work. The devices of the Ancients are years ahead of what we have today. Consider how much the rifle has evolved in 300 years and apply that to the rifle of 300 years from now. Game balance also plays a part. The characters cannot have everything handed to them on a silver platter. Also, a great deal of fun can be had by presenting

the characters with strange objects that would be immediately recognizable to us today.

Q: Why are characters automatically hit when struck by surprise?



A: This reflects how helpless a being can be in an ambush situation. It also gives player characters advantages against the many powerful creatures of the game, and can work for the characters more often than against them. If you are getting surprised too often, be more careful with your next character!

Q: My referee isn't checking for reaction with the NPCs we meet. She says she has them already planned out.

A: In all role-playing games, the referee calls the shots, right or wrong. This case is perfectly acceptable if the breaks go with the group as often as against them. When it stops being fun, then it's time to get a new game referee.

Q: I have a list of weapons I would like to use in the game. What Weapon Class should they be, and what damage would they cause?

A: The following are some suggested values for the weapons you sent to us. How your referee wants to handle these weapons could be vastly different, however.

Bolo: W/C 1, DAM 1d8

Sheriken: W/C 2, DAM 1d4

Quarterstaff: W/C 2, DAM 1d6

Machine gun: W/C 11, DAM 4d8

Vibro Sword: W/C 5, DAM 40 pts.

Thrown human body: W/C 1, DAM 1d6

Fist: W/C (per attacker's HD), DAM 1d6

Q: I have some questions on the mutations in the GAMMA WORLD game:

1. In *Absorption*, is a laser a heat weapon or a light weapon?
2. In *Aromatic Powers*, can the characters resist the desire for their favorite food if they are not hungry?
3. In *Chameleon Powers*, what is a

“jutation?”

4. In *Direction Sense*, can a mutant really locate any object he/she wants?

5. In *Displacement*, can the mutant actively face danger and not let himself/herself be displaced?

6. Does *Energy Metamorphosis* make a mutant immune to the harmful effects of radiation?

7. In *Electrical Generation*, can the mutant turn off this power so that allies and friends may safely touch the object?

8. Is there any way to tell if a *Force Field Generation* power is in use?

9. How hot is the heat from the *Heat Generation* mutation?

10. In *Kinetic Absorption*, is it 25 points per weapon or a total of all weapons used in that attack round?

A: The following should take care of these problems.

1. All laser attacks are considered light weapons.

2. The desire to acquire the food transcends being hungry or in danger, etc. The mutant should be told right away that it is being drawn in the direction of the smell and should be allowed to react with all weapons or mutations at his/her command.

3. The word “jutation” is a typo. It should read “mutation.”

4. Copy was dropped here. It should read “or locate any owned object held in the last eight hours.”

5. The movement action happens even if the mutant tries to avoid being displaced.

6. *Energy Metamorphosis* does make a mutant immune to radiation.

7. Since the power is a conscious one in humanoids and mutated animals, they may turn off the effect if they desire.

8. The use of the *Force Field Generation* mutation usually causes the user to glow slightly. This is not the case in areas of continual darkness where mutants have been raised. Here, the mutation is not noticeable.

9. The heat from the *Heat Generation* mutation is approximately 480 degrees F. Although the mutant is immune to the blasts from its hands, it is not immune to the damage of fire caused by the heat.

10. The 25 points per attack is from all weapons. If the mutant took a total of 27 points of damage from maces and clubs, it would take 2 points that round in actual damage.

Q: Considering the hit points of all of the player characters in the game, weapons

like swords and arrows do minor damage. This isn't very logical, is it?

A: Sometimes it's necessary to sacrifice “realism” in the interest of game balance and playability; this has been done in the combat system of the GAMMA WORLD game. Remember, however, that right along side bows and swords are things like death rays that kill on contact or stun whips that render the victim unconscious at a touch with no hope of resistance (unless the referee has designed a new mutation against it). Logic can often render a referee defenseless, but it doesn't stop a game designer long. Swords do what they have to do in the game so that every mutant Conan in the land is not more powerful than men in powered armor.

Q: I'm trying to establish a timeline for the GAMMA WORLD game. What year is it when the game takes place?

A: The old edition of the rules said the game begins in A.D. 2471; the new edition starts the campaign in A.D. 2450. You may use whichever date you wish, though the latter is preferred. For your information, an article on the past history of the GAMMA WORLD game environment is being prepared and may see print in the near future in the ARES™ Section.

Q: In DRAGON® Magazine #75 (July 1983), an article appeared which described a new robot type called a Cyber-Netter. What do these things do with PCs they manage to capture?

A: The author of the article (Roger Moore) left this problem open for the referee to solve. Adventures may be designed around the home base of the Cyber-Netters, which will probably be a heavily fortified Ancients site where captives are being used for biological experiments or some other mad purpose. It's all left up to you to develop as you like.

Q: Can the GAMMA WORLD game be linked up with the old *Metamorphosis Alpha* game?

A: The former game was derived from the later, and the systems are similar enough that a good referee could substitute the improved GAMMA WORLD game mechanics for the older MA system; all that would be needed would be the plans for a 50-mile long starship. . . .

**BEYOND THE QUADRA ZONE**

The year is 2615.  
Interstellar space travel has been commonplace for centuries. But the human expansion of the galaxy has been confined by four barrier zones of alien design. A recent invention has made it possible to pass through the fourth barrier zone, known as the Quadra Zone. Come explore the unknown regions of space that lie "BEYOND THE QUADRA ZONE".

BEYOND THE QUADRA ZONE is a new play by mail game. Turns are run once a week and include your colony's growth and development (population growth, training options, manufacturing options, buying & selling lists, mining, inventions, revenue, etc. . . .). It also includes your fleet's movement, combat, a list of your specialized crewmen and their personal proficiency factors, object testing options, planet options, landing parties discovering: lost civilizations, dangerous aliens, lost alien devices, and others. You will also encounter new star systems, unknown objects floating in space, advanced civilizations that may aid or attack your fleet, and much more. We do not tack on any hidden costs for combat or alliances. The printout is in an easily understood, narrative style.

For \$2.00 we will send you your first instruction booklet, a free turn set-up, and for an introductory time only the first 100 people to respond will receive 1 free turn. Each additional turn thereafter is \$4.00 and includes all your ship and colony options. To receive your game material or for more information call (201) 337-3437 (Mon. - Sat.) or send your name, address, and \$2.00 to Quest Games, Inc., P.O. Box 210, Oakland, NJ 07436.

# Silverdawn\*

\*by Entertainment Concepts, Inc.

## WOULD YOU EVER DREAM

of slyly searching for clues of treasure?  
of saving beautiful maidens?  
of slaying fierce monsters?

of hearing your name spoken in awe?  
of obtaining vast wealth?  
of having men look to you as their leaders?

OF HAVING THE TIME OF YOUR LIFE??

Read what experienced PBM Gamers have to say about **SILVERDAWN**:

*"I think this is the best fantasy game of all time, PBM or otherwise! Although it is played by mail it's much better than any of the boxed role playing games!"*  
—Jose Pena

*"I am enjoying the game immensely. Each turn brings something new and unexpected. I also enjoy the diversity. My mage has required more brainwork and been more challenging. On the other hand, my minstrel has been more action-packed and exciting. I never expected to find a gate to another world in the course of this adventure, but the surprises make it more fun."*  
—Alan Dinse

*"This is a GREAT game!"*  
—Jack Norhanian

*"I'd like to compliment you on **SILVERDAWN**. It's interesting, challenging, and fun. I work nights full time and go to college full time during the day so I don't have as much time as I used to for campaigns here. **SILVERDAWN** fits the bill perfectly!"*  
—Terry Johnson

*"Just a note of thanks from a newly devoted fan. I have tried several of your competitor's PBM computer games and found them akin to reading the instructions for filling out the 1040 Tax Forms . . . full of computer jargon which is needed to tell their machines what you want to do. What a surprise and a pleasant change to find that I deal directly with good, old fashioned real people at your place! The game is really a pleasant thing too, its been a while since anyone came out with a fresh approach, and a totally logical system of magic, etc. You have a coherent and simple system which defies your competition. Best of luck and keep up the good work!"*  
—Wesley A. Miley

# \$5,000.00 QUEST TOURNAMENT

Now you can enter the richest tournament in the history of Correspondence Gaming!! The **SILVERDAWN** Quest Tournament will offer a **\$5,000** first prize, a \$500 second prize, a \$50 third prize; and numerous smaller prizes awarded during the course of the competition. A fabulously interesting and exciting adventure has been prepared . . . replete with all the dangers, challenges, and puzzles that you could wish for. And the first player to complete this Quest will win **FIVE THOUSAND DOLLARS!!!**

Entry to the **SILVERDAWN** Quest Tournament is open only to the players of ECI games, and costs only \$3.00. Quest Tournament moves cost only 50 cents each, and are played along with your **SILVERDAWN** or 'Star Trek, the Correspondence Adventure' moves. Your entry to either of our games now makes you eligible to compete for the richest prize in the history of our hobby!

**SILVERDAWN** is the ultimate play by mail fantasy campaign. Having already received an enthusiastic response from players who enjoy having total freedom of creative decision, **SILVERDAWN** lets you guide heroic characters thru fantastic adventures.

Each move allows you to detail up to **3 pages** of actions and contingencies. Every move will be promptly responded to. Every month you will receive a copy of **SILVERQUEST**, the newsletter that tells the stories of the greatest heroes in **SILVERDAWN**. Each issue will also contain contest announcements, with the winners receiving cash prizes!

**ENTER NOW!!** Join the hundreds of adventurers already creating tomorrow's legends in **SILVERDAWN**.

Entry is \$7 for the rules and first move.

Each move thereafter is \$3.

If not completely satisfied, please return rules for a complete refund.

Name: \_\_\_\_\_ Age \_\_\_\_\_ I prefer: Fighter \_\_\_\_\_ Mage \_\_\_\_\_ Thief \_\_\_\_\_

Address: \_\_\_\_\_ Spy \_\_\_\_\_ Merchant \_\_\_\_\_ Minstrel \_\_\_\_\_

City: \_\_\_\_\_ State: \_\_\_\_\_ Zip Code: \_\_\_\_\_ Cleric \_\_\_\_\_ Ranger \_\_\_\_\_ Engineer \_\_\_\_\_

I would like to run \_\_\_\_\_ characters in the land of **SILVERDAWN**. Enclosed is \$7 for the first and \$3 for each additional character

... In addition, please enter me in the \$5,000 **SILVERDAWN** Quest Tournament.  
An additional \$3 is enclosed to cover the cost of this entry.

**Mail to: Entertainment Concepts, 6923 Pleasant Drive, Charlotte, NC 28211**



# SF/gaming convention calendar

## **X-CON 8, June 8-10**

This convention will be staged at the Olympia Resort in Oconomowoc, Wis. Activities include sports, a masquerade ball, an art show, and feature-length movies. Guests of honor are Wilson "Bob" Tucker, Robert Lynn Asprin, Jo Clayton, and artist Rowena Morrill. For further information and registration rates, contact: X-Con 8, P.O. Box 7, Milwaukee WI 53201.

## **GENGHIS CON 6, June 15-17**

Sponsored by the Denver Gamers Association, this gaming event will be staged at the University of Denver, 2055 East Evans, Denver, Co. Over 150 different tournaments, events, and demonstrations dealing with board games, miniatures, and role-playing adventures are scheduled. Admission is free on Friday, \$12 for the entire weekend, \$9 for Saturday only, \$6 for Sunday only; and it is available at the door. For further information about the convention, telephone: (303) 797-8368.

## **DESOLATION CON, June 16**

This convention will offer board and role-playing games, miniatures, costume contests, an art show, and a movie room. For more information, send a self-addressed, stamped envelope to Desolation Con, P.O. Box 297, Richland WA 99352.

## **MICHICON GAMEFEST '84, June 16-17**

The Metro Detroit Gamers are sponsoring this event to be staged at the Southfield Pavilion in the Southfield Civic Center, located just north of Detroit. Exhibitors, seminar speakers, tournament masters, and advertisers are all welcome to participate. Activities included are board games, role-playing tournaments, miniatures events, and seminars. For additional information, contact: Michicon Gamefest '84, Metro Detroit Gamers, P.O. Box 656, Wyandotte MI 48192.

## **POLYCON '84, June 22-24**

This convention will be held at the Cal Poly Campus in San Luis Obispo, Cal. It will feature events to satisfy every wargamer and fantasy role-player, including *Kingmaker*<sup>™</sup>, *Ace of Aces*<sup>™</sup>, *Cosmic Encounters*<sup>™</sup>, and AD&D<sup>®</sup> tournaments. Dealer booths and positions for game masters are also available. For more information, contact: SAGA, Box 168, Julian A. McPhee, University Union, Cal Poly State University, San Luis Obispo CA 93410.

## **SEAGA '84, June 22-24**

This gaming convention will take place at the Holiday Inn located on Delk Road in Marietta, Ga. (a suburb of Atlanta). Featured are FRP, miniatures, and other gaming tournaments. A video room and demonstrations by medieval and Civil War

recreation groups will also be provided. For further details, send a self-addressed, stamped envelope to SEAGA '84, P.O. Box 930031, Norcross GA 30093.

## **SUMMER MINICON '84, June 23-24**

To be held at the Gateway Auditorium at 66th and O St. in Lincoln, Neb., this event will feature role-playing games, board games, and miniatures events. For more information, contact: Merl Hayes, c/o Hobby Town, 134 North 13th Street, Lincoln NE 68508, or call (402) 476-3829.

## **WILCON, June 23-25**

Fifty free events will be featured throughout this convention, which will be held in Wilmington, Ill. Memberships are \$4 per day, or \$10 for the weekend. For more information about this gaming convention, contact: Donald Heck, 1790 Vista Drive, Wilmington IL 60481, or phone (815)476-7385.

## **WINDSOR GAMEFEST II, July 7**

This gaming convention is hosted by the Windsor Role Players Association and will be held at St. Clair College, 2000 Talbot Rd., Windsor, Ontario, Canada. For more information, send a self-addressed, stamped envelope to: Windsor Role Players Assoc., c/o Eric Johnson, R R #1, Hwy #3, Oldcastle, Ontario, Canada NOR 1L0.

## **OCTACON I, July 13-15**

The Staff of Giza will be coordinating this convention; all proceeds will be donated to the Augustana Speech and Hearing Center. Donations at the door will be \$5 (which includes one free game). For further information about this event, contact: Staff of Giza, P.O. Box 772, Rock Island IL 61204, or call (309) 788-8450.

## **BANGOR AREA WARGAMERS CONVENTION, July 21-22**

This eighth annual convention will be staged at the Orono Recreation Center in Orono, Maine. Arrangements have been made for participants to stay over the night of July 21 in the Recreation Hall, so anyone planning to attend should bring proper sleeping gear. Registration for the weekend is \$5 at the door; no preregistration is available. For more details, send a self-addressed, stamped envelope to: Edward F. Stevens, Jr., 32 Masonic Street, Rockland ME 04841, or telephone (207) 596-0338.

## **SUMMERCON 84, July 27-29**

To be staged at the MIT Student Center, Cambridge, Mass., this convention will feature FRP games, board games, and miniatures. Door and event prizes will be awarded. For information, contact: SummerCon 84, 122 Bowdoin St., Apt. 77, Boston MA 02108.

## **ATLANTA FANTASY FAIR 10, Aug. 3-5**

Touted as the South's largest gaming convention, this event will be held at the Omni Hotel and World Congress Center. Guests include Larry Niven, Chris Claremont, Richard Pini, Robert Bloch, Forrest Ackerman, Al Williamson, and many more. Activities include *Champions*<sup>™</sup>, *Star Fleet Battles*<sup>™</sup>, and D&D<sup>®</sup> tournaments. A costume contest, model and sculpture competitions, an amateur film festival, an art show, a dealers' room, and twenty fantasy films are also scheduled. Pendragon Galleries will have a special art exhibition with paintings by all top fantasy artists, including Boris Vallejo, Michael Whelan, and Rowena Morrill. Registration fees are \$19 by June 30, and \$25 at the door. For a free 16-page progress report, send a self-addressed, stamped envelope to: Atlanta Fantasy Fair, P.O. Box 566, Marietta GA 30061, or call (404) 425-8095.

## **MYSTICON 3, August 3-5**

To be held at the Holiday Inn — Tanglewood in Roanoke, Va., this convention will include an art show, role-playing games, video movies, and a masquerade. Guests of honor will be Karl Wagner, Somtow Sucharitkul, Paul Dellinger, and Rudy Rucker. Registration fees are \$15 at the door; tickets for the luncheon buffet banquet are \$12 each. For more details about the convention, contact: Mysticon 3, P.O. Box 1367, Salem VA 24153.

## **OMACON 4, August 3-5**

Sponsored by the Omaha Beach Gaming Club, this convention will be staged at the Holiday Inn — Old Mill, 108th and Old Mill Road in Omaha, Neb. Science-fiction Guests of honor include Poul Anderson, Karen Anderson, and Melinda Murdock; Dan Charleston will be toastmaster. Featured events are a NASA display, a buffet banquet, fantasy role-playing games, board games, miniatures, a dealers' room, an art show, and panel discussions and demonstrations. Registration are \$13 until August 1, and \$15 at the door. Banquet tickets cost \$10 in advance. For additional details concerning this event, contact: Omacon 4, 2518 So. 167th St., Omaha NE 68130.

## **TIMECON '84, Aug. 3-5**

This convention will be held at the San Jose Convention Center in San Jose, Cal., Events include board games, video games, science-fiction and fantasy role-playing adventures, Doctor Who games, an art show, a costume contest, and a dance. John Pertwee, James P. Hogan, Eric L. Hoffman, and Dave Smeds will be among the guests of honor. For further information, contact: Timecon '84, 1025 Jefferson St., Santa Clara CA 95051.

#### ARCANA CON II, Aug. 23-26

To be staged at the University High School in Parkville, Melbourne, Australia, this convention will include board games and role-playing games and tournaments. For further information, contact: Arcanaccon, C/- 105 Cardigan Street, Carlton 3053, Australia.

#### EARTHCON IV, Sept. 7-9

This convention will be held at the Holiday Inn in Cleveland, Ohio. Events will include workshops, panels on game design and scenario writing, tournaments, board games, role-playing games, a masquerade, "filksinging," an art show, a *Star Trek* festival, and much, much more. Poul Anderson, Steve Jackson, Rebecca M. Meluch, Margaret Middleton, and Tom Moldvay will be among the guests of honor. For more information about this convention, write to Earthcon IV, P.O. Box 5641, Cleveland OH 44101.

#### TENTH ANNUAL COUNCIL OF NATIONS, Oct. 5-8

This special anniversary convention will include open fantasy role-playing gaming, mini-battles, a mini-painting contest, game instruction, a costume contest, an auction, and numerous tournaments. For further information, send a self-addressed, stamped envelope to I. M. Lord, SWA 10th Council, 1639 Eastern Parkway, Schenectady NY 12309.

#### WINGAMES V, Oct. 5-7

This convention centers around a large AD&D® tournament, with prizes and trophies for most events. Admission is free at the door, though a small charge (50¢ to \$3) exists per event entered. For details, contact: University of Manitoba Gaming Club, Box 80, University Center, University of Manitoba, Winnipeg, Manitoba, Canada R3T 2N2.

#### LIN-CON VI, Oct. 12-14

To be held at the Gateway Auditorium at 66th and O Streets in Lincoln, Neb., this convention will feature board games, miniatures events, and role-playing tournaments. For additional details, contact: Merl Hayes, c/o Hobby Town, 134 North 13th St., Lincoln NE 68508, or call (402) 476-3829.

#### CONSTELLATION III, Oct. 19-21

This convention will be staged at the Sheraton Inn located in Huntsville, Ala. master of ceremonies will be Frank Kelly Freas, and guests of honor will include Gordon R. Dickson, Mark Maxwell, Maurine Dorris, and Tim Bolger. Featured events are readings, panels, autograph sessions, a masquerade, hearts and gaming tournaments, an art show, and an auction. Registration fees for the convention are \$13 until September 15, and \$16 at the door. For additional information about this event, send a self-addressed, stamped envelope to Con-

stellation III, P.O. Box 4857, Huntsville AL 35815.

#### CRUSADER CON IV, Oct. 19-21

This event will be held at the Metropolitan State College campus in Denver, Colo. Events will include *Diplomacy*®, *Kingmaker*™, AD&D®, *Traveller*®, *Squad Leader*™, *Car Wars*™, and *Star Fleet Battles*™ tournaments. Registration is \$8 until 1 October, and \$10 thereafter. For more details, contact: The Auraria Gamer's Club, P.O. Box 13395, Denver CO 80201-3395.

#### ICON IX, Oct. 26-28

This annual science-fiction convention will be staged at the Abbey Inn in Iowa City, Iowa. Guests of Honor will be Dean Ing and Wilson Tucker. Registration fees are \$10 until October 1, and \$15 thereafter. Art show and huckster inquiries are welcome. For further information about the convention, contact: Icon IX, P.O. Box 525, Iowa City IA 52244-0525.

#### R-CON 1, Nov. 2-4

This gaming convention will be held at the Genesee Plaza Holiday Inn in Rochester, NY. Guests include David Gerrold and Forrest J. Ackerman. Featured will be role-playing and board games, panels, films, an art show, and a masquerade. Registration fees are \$10 until September 1, and \$12 at the door. Contact: R-Con 1, P.O. Box 1701, Rochester NY 14603. □

# ORIGINS 84

THE NATIONAL ADVENTURE-GAMING CONVENTION  
June 21st - 24th, 1984  
Dallas Market Hall North  
I-35 and Industrial Blvd

**ORIGINS 84** will be held at the Dallas Market Hall North.  
This year's Origins will include tournaments in:

BOARDGAMING

MINIATURES

ROLE-PLAYING

ROLE-PLAYING MINIATURES

**ORIGINS 84** will also feature many famous speakers and guests.  
Don't miss **ORIGINS 84**, the national wargaming convention.

For more information, send SASE to:

**ORIGINS 84**  
P.O. Box 59899  
Dallas TX 75229

# ORIGINS 84: A Texas-sized show

Maybe, as Texans tell us, everything just naturally grows bigger in the Lone Star State. But whether that's always true or not, the ORIGINS 84 Gaming Convention just happens to be in Texas — and it's shaping up as the biggest ORIGINS convention yet.

The Dallas Market Center and two auxiliary sites will be filled with the sights and sounds of gaming from June 21-24, when the ORIGINS convention will be staged for the tenth consecutive year. The anniversary show has everything you could expect to find at a big gaming gathering, and a few things you might not expect.

The sponsors of the show, the Dallas-Fort Worth Gamemasters and the Game Manufacturers Association, have put together an agenda that includes more than 250 events (tournaments and other sorts of competitions) covering all aspects of gaming, and more than 200 admission-free demonstrations, seminars, and displays.

It's possible to not enter a single tournament and still find yourself with enough to fill up four days' worth of convention-going. The Dallas Market Center will be the site of the largest Exhibit Hall in the history of the convention, where every major adventure gaming company will be

represented — a total of more than 175 booths — with new and existing products for sale. All seminars and demonstrations will take place at the Market Center, as will the Awards Ceremony where the winners of the Charles Roberts Awards and the H. G. Wells Awards for 1984 will be spotlighted. There'll be plenty of room available for open gaming around the clock, and a video room on the premises. The Market Center will be the site of all single miniatures events.

The rest of the convention's competitions will be fought out at two nearby hotels. The Holiday Inn-Brookhollow will house all role-playing events, and the Regent Hotel will provide the battlegrounds for all boardgames and miniatures tournaments. Both of the hotels are only a five-minute ride from the Market Center, and a free shuttle bus service between the Market Center and each remote site will operate continuously during the convention's official hours (2 p.m. to 1 a.m. Thursday, 8 a.m. to 1 a.m. Friday and Saturday, 8 a.m. to 6 p.m. Sunday).

The list of special events and significant happenings is too long to present in detail. There will be auctions, of course; minia-

tures painting contests with dozens of different categories; a trivia contest; a unique "Champion of Champions" tournament; and lots more activities.

Considering the number of special guests scheduled to appear, the odds are pretty good that you'll be able to rub elbows with at least one of them. The list includes Richard Pini, author of the *Elfquest* saga; C. J. Cherryh, noted fantasy and science-fiction author; Robert Asprin, author of the *Thieves World* series; Fred Saberhagen, author of the *Berserker* series; Richard Berg, well-known game designer; Chris Crawford, designer of *East Front* and other Atari games; Dave Arneson, co-author of the *DUNGEONS & DRAGONS*® game; Marc Miller, creator of the *TRAVELLER*® game; Jennifer Roberson, author of *Shape-changer*; and just about everybody who's anybody in the gaming industry.

At-the-door admission prices are \$20 for the weekend or \$8 for a one-day pass. According to the sponsors, plenty of free parking is available at each of the three sites, so anyone who decides to come at the last minute need not worry about getting turned away for lack of a place to put the car. After all, this is Texas. . . .

□

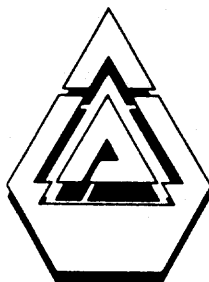

## ATLANTICON '84

AUGUST 3, 4, 5

TOWSON STATE UNIVERSITY  
TOWSON, MD

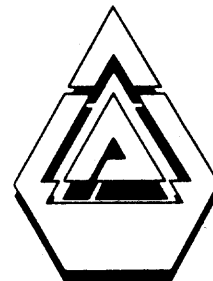

**\*War Games**

**\*Exhibits by Major Manufacturers**

**\*Computer Games**

**\*Role Playing Games**

**\*Miniatures**

**\*Sports Games**

**\*Seminars**



**\*New Product Displays**

**\*Movies**

**\*Inexpensive On-Campus Lodging**

**\*Auctions**

**\*Meal Plans**

**\*Pre-Registration**

**\*OFFICIAL AH SQUAD LEADER TOURNAMENT**

**\*OFFICIAL GDW TRAVELLER TOURNAMENT**

**\*OVER 200 EVENTS & 80 BOOTHS**

**In short, everything you've come to expect from a major gaming convention is once again available this summer at the East Coast's largest gaming convention. The same people who brought you ORIGINS I, II, V, VI, and VIII and who will sponsor ORIGINS XI next year have joined forces to host the largest gaming convention east of Dallas. Contact: ATLANTICON '84, P.O. Box 139, Middletown, NJ 07748. (301) 298-3135**

# Capture your Fantasy

Great Galy Orc  
Characters painted by Scott Pryor, Dallas, Texas.

Through our newest generation of characters, games & accessories.



## Wargames carries only the best true fantasy characters and accessories.

We are the exclusive distributor for Essex, Chronicle and Dixon 25mm miniatures. These lines add new dimensions to your role-playing games with superior craftsmanship and wide variety.

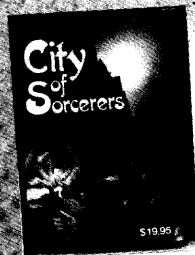

## Fall under the spell of exciting Standard Games.

The best gets better with challenging Standard Games and accessories. Experience the spellbinding City of Sorcerers, the man to man combat of Samurai Blades, or the one on one medieval action of Siege and Cry Havoc, and many other popular games. They all offer a vast variety of strategic situations to challenge both new and experienced players.



# WARGAMES

1410 Promenade Bank Center • Richardson, TX. 75080

Expand your imagination with Dungeon Accessory Packs, maps and many other treasures.

If none of these stores are near you call 214/387-0360 for more information. Or send \$1.00 to Wargames for a sample fantasy character and catalogs.



Our superior products available at these better stores near you. (Not all products available at all stores.)

- |  |   |  |  |   |   |
|--|---|--|--|---|---|
| <p><b>ALABAMA</b><br/>Homewood Toy &amp; Hobby<br/>2930 S. 18th St.<br/>Homewood</p> <p><b>CALIFORNIA</b><br/>Black North<br/>8821 Nevada Blvd.<br/>Pasadena<br/>1760 E. Colorado Blvd.<br/>Pasadena<br/>East Armory<br/>119 S. Golden Way<br/>Burbank<br/>East Brothers<br/>8821 Nevada Blvd.<br/>Northridge<br/>Military Emporium<br/>700 N. Johnson<br/>El Cajon</p> <p><b>FLORIDA</b><br/>Complete Strategist<br/>402 Stirling Rd.<br/>Davie<br/>705/944-5660</p> <p><b>GEORGIA</b><br/>Sword of the Phoenix<br/>1505 Ashford Dunwoody Rd.<br/>Atlanta</p> | <p><b>HAWAII</b><br/>Legionnaire Hobby<br/>1415 Gillingham Blvd.<br/>Honolulu</p> <p><b>ILLINOIS</b><br/>Games Plus Hobbies<br/>70 W. Jussie Ave.<br/>North Prospect<br/>Plymouth Hobbies<br/>925 Greenwood<br/>Waukegan<br/>Prospect Military Models<br/>28 W. 140-Highlake Rd.<br/>Winfield<br/>Royal Hobby<br/>5980 E. State St.<br/>Rockford</p> <p><b>INDIANA</b><br/>The Bandboxes<br/>2438 E. 62nd St.<br/>Indianapolis<br/>Swordling To Do<br/>Green Tree Mall<br/>Clarksville</p> <p><b>KANSAS</b><br/>King's Crown<br/>6865 W. 105th S.<br/>Overland Park<br/>Midland Games<br/>2966 W. Central<br/>Wichita</p> | <p><b>KENTUCKY</b><br/>Something To Do<br/>Bashford Manor Mall<br/>Louisville</p> <p><b>MARINE</b><br/>Hobby Shack<br/>135 Main St.<br/>Waterville<br/>Toy Soldier<br/>Front St.<br/>Barn</p> <p><b>MARYLAND</b><br/>Complete Strategist<br/>231 Park Ave.<br/>Baltimore<br/>301/366-1665</p> <p><b>MASSACHUSETTS</b><br/>Complete Strategist<br/>701 Massachusetts Ave.<br/>Boston<br/>617/267-2451</p> <p><b>MICHIGAN</b><br/>Comic Kingdom<br/>13600 Grand<br/>Detroit<br/>Widers Hobby<br/>3012 Corvus Rd.<br/>Flint</p> | <p><b>MISSOURI</b><br/>Epic Gallery<br/>68 Village Sq. Shopping Center<br/>St. Louis<br/>Yankee Doodle<br/>6831 Longview Rd.<br/>Kansas City</p> <p><b>MONTANA</b><br/>Hobby Land<br/>811 Central Ave.<br/>Great Falls<br/>Hobbie Shoppe<br/>Southgate Mall<br/>Missoula</p> <p><b>NEW JERSEY</b><br/>Complete Strategist<br/>215 Glenridge Ave.<br/>Montclair<br/>201/744-6622</p> <p><b>NEW YORK</b><br/>Complete Strategist<br/>41 E. 33rd St.<br/>New York City<br/>212/685-3880<br/>Complete Strategist<br/>320 W. 57th St.<br/>New York<br/>212/582-1272<br/>Men At Arms<br/>RR2, Box 700C<br/>Middle Island</p> | <p><b>NORTH CAROLINA</b><br/>Hungates<br/>Four Seasons Mall<br/>Greensboro<br/>Hungates<br/>Crabtree Valley Mall<br/>Raleigh</p> <p><b>OHIO</b><br/>Breastplate<br/>3002 Center Rd.<br/>Poland<br/>University Miniatures<br/>2413 N. High St.<br/>Columbus</p> <p><b>PENNSYLVANIA</b><br/>Complete Strategist<br/>2011 Walnut St.<br/>Philadelphia<br/>215/563-2960<br/>Complete Strategist<br/>254 West Dekalb Pike<br/>Valley Forge Shopping Center<br/>King of Prussia<br/>215/265-8562</p> <p><b>TEXAS</b><br/>Armadillo Soldier Shop<br/>Northtown Mall<br/>Dallas<br/>Dibbles Hobby<br/>1029 Donaldson Ave.<br/>San Antonio</p> | <p><b>WASHINGTON</b><br/>Merlyn's<br/>W. 621 Mallon<br/>Spokane<br/>Sword &amp; Shield<br/>309 SW 122nd St.<br/>Seattle<br/>Triple Alliance<br/>10328 Main St.<br/>Bellevue</p> <p><b>WISCONSIN</b><br/>Galaxy<br/>101 Division St. N.<br/>Stevens Point<br/>Napoleons<br/>3948 N. Maryland Ave.<br/>Shorewood</p> <p><b>VIRGINIA</b><br/>Complete Strategist<br/>103 E. Broad St.<br/>Falls Church<br/>703/532-2477<br/>Campaign Headquarters<br/>47 E. Queensway Mall<br/>Hampton</p> |
|--|---|--|--|---|---|

\* Samurai Blades available mid-to-late June, 1984.



# GAMERS' GUIDE

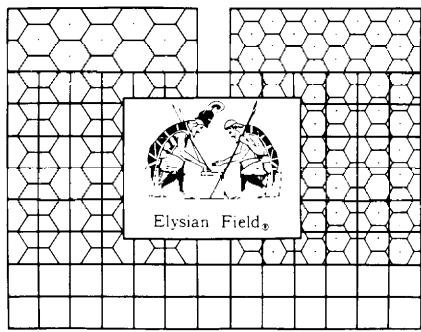

Elysian Field, grid board \$7.50  
 yellow 1" square grid on rigid transparent plastic  
 lift to place maps and cutouts underneath

Elysian Field, hex sheet, double sided cardboard  
 modified hex patterns match square grid,  
 two different scales, one on each side \$3.00

SET: Elysian Field, grid board and hex sheet \$9.50

SAMPLE MARKER SET \$3.50  
 \*dry erase \*alcohol \*water \*wax\*

send to:  
 Britton Designs  
 5131 Blackstone Ave.  
 Chicago, Illinois 60615

include \$1.50 for shipping  
 (Illinois residents include 5% tax)

## BATTLE OF THE GODS



Players strive for control of the universe using their own god-like powers to hurl matter, create worlds, form life, control populations and much more. The game features a unique map and movement system which allows strategies to come into play that are in no other game.

**BATTLE OF THE GODS** is computer moderated, has a 24 hour turnaround time, and a backup system if you ever miss turns. Send \$12.00 for rulebook, set-up, and first two turns (turns \$3.50 each), or send \$1.50 for rulebook, or write for our free flyer.

*Integral games* P.O. BOX 13562  
 ARLINGTON, TX  
 U.S.A. 76013

## Falcon

**Miniatures**

**NEW 25 mm. Fantasy Figures NEW**

Send \$2.00 for listing and Sample Figure to:

**Falcon Miniatures**  
 1 High Street • Suite 102  
 Medford, MA 02155

### A Totally New Concept in Dungeons! AFTERNOON ADVENTURES

Tired of unfinished, long forgotten adventures that have "captured" your characters for ages? Try our new complete 4 hour maximum modules. Tons of treasure, monsters, and surprises. All levels, please specify. Surviving party members will go up one level, at least.

\$3.00 for each ready to play module.

**Free Elf Publications**  
 P.O. Box 9533  
 Midland, Texas 79708  
 915-694-7220

## YOUR SOURCE

for a wide range of figures and games

SPI, TSR, GDW, AH,  
 GHQ, Grenadier, Ral Partha, Citadel, Task Force, Yaquinto & more

Everything for D&D® and Traveller games  
 CATALOG: \$1.00 - refundable on 1st order  
 1-413-737-8543

**THE TIN SOLDIER**  
 Dept. D, 9 Historic Court Place  
 Springfield MA 01103

MILITARY MINIATURES

## Your own Full Figure CHARACTER

8 1/2" x 11"

Rendered by Professional Illustrators \$10<sup>00</sup> ea.

fantasy role playing  
 super hero

for FREE character description sheet, write:

**ANVIL™ ENTERPRISES**  
 P.O. Box 4028  
 Indialantic, FL 32903



## "MOST OUTSTANDING CARD GAME OF 1982..."

Awarded in August, 1983  
 Strategist's Club

This honor was bestowed upon **JASMINE: THE BATTLE FOR THE MID-REALM®** collector card game by those gamers lucky enough to have discovered it.

As a LIMITED EDITION, this collection is each individually numbered and signed by the artist/designer, Darlene. When it is sold out, no more will be available. Many gamers have bought two copies — one to play and one to save.

Now Jasmine Publications wishes to celebrate the anniversary of its fine award by offering a special discount to gamers. Buy one game at the regular Mail order price of \$13.00 and receive a second copy for half price! This offer expires August 31st!

**Two card games for \$19.50**

 **JASMINE PUBLICATIONS**  
 P.O. Box 684  
 Lake Geneva, WI 53147

## ATLANTIS

A COMPLETE FANTASY WORLD  
 COMING SOON FROM

## BARD GAMES

 521 FRIEDMAN DR • WAUKESHA, WI 53186

**10-25% OFF**  
 SUGGESTED RETAIL ON ALL  
 TSR • RAL PARTHA • GRENADIER

**48 HR. SHIPPING**  
 FOR C.O.D.'S & MONEY ORDERS  
 SEND \$100 FOR CATALOG



## COMPUTER GAMES

SSI	Apple	Atari	Com.64	List Price	Our Price
Galactic Adventures	X			59.95	41.97
Bomb Alley (war)	X			59.95	41.97
Germany 1985 (war)	X		X	59.95	41.97
Question (adv)	X	X		49.95	34.97
Computer Baseball	X		X	39.95	27.97
Cytron Masters (arc)	X	X		39.95	27.97
Cost: c Balance of I ts:att	X	X		39.95	27.97
Fortress (strat)	X	X	X	34.95	24.47
Broderbund					
Chopflifer (arc)	X	X	X	34.95	24.47
Lode Runner (arc)	X	X	X	34.95	24.47
Muse					
Castle Wolfenstein	X	X	X	29.95	20.97
Sirtech					
Wizardry Series	X				30% off
Ultima II	X	X		59.95	41.97
L'ima - I, Apple only, Hayes Vacu - I, Jays'tick for the Apple				44.95	31.47

To Order: Send check or money order to:  
 The Diskon Master  
 P.O. Box 1362  
 Jareseville, WI 53545

Add \$2.00 for postage and handling.  
 Specify computer type.

Write for a complete listing  
 for more information call (508) 756-1110

**Don't Go Adventuring  
Without Your Sword!**



Approx. 2 1/2"

**Close To The Edge**  
presents

**A Handcrafted  
Miniature**

designed by their  
**Master Knifemaker**

Each Sword is a Work of Art  
Created In  
Nickel Silver, Brass, and Ivory  
or Exotic Wood  
Available in

Pin or Pendant

Pendant Includes Sterling Chain  
Send \$43.95 Check or M.O. to

**Close to the Edge**  
P.O. Box 406

High Falls, N.Y. 12440

Please Specify Exotic Wood or Ivory  
Allow 2-4 Weeks for Delivery  
(N.Y. Residents Add 7% Sales Tax)

**\* GREAT PRICES \***

RAL PARTHA      CITADEL  
GRENADIER      TSR      More!

**FAST SERVICE!**

Send \$1 for Catalog  
(Refundable with your  
first order)

**IMAGINATIVE MAIL ORDER**  
Box 100  
Hawleyville, CT. 06440

## The Wizard's Corner

Saskatoon's FRP Game Centre  
Fantasy games  
& figurines

801 Broadway Avenue  
Saskatoon, Saskatchewan  
Canada S7N 1B5

Drop in, or  
send \$2 for catalog!

**USE  
SOME MAGIC**

patented  
1 year guarantee

**DRAGONBONE**

Electronic D3, D4, D6, D8,  
D10, D12, D20, D%  
Dice Wand

Comes in Charcoal, Bone, or Blood colors  
\$24.95 plus \$100 shipping

Send orders to:  
D.B. Enterprises  
25 Sunhill Lane  
Lemont, IL 60439

**WARGAMES  
WEST**

FOR ALL YOUR  
GAMING NEEDS  
CALL OR WRITE FOR  
FREE CATALOG

1-800-545-6258

**WARGAMES WEST**  
3422 Central Ave SE  
Albuquerque, NM 87106

### Universal Terrain Stamps

Design your own games and maps with  
universal symbols. Quick and easy to use!

Set of  
eight high  
quality  
**15mm**  
rubber  
stamps  
\$19.99 for  
a set of 8

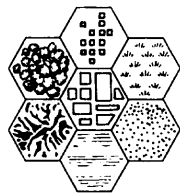

City  
Town  
Mountain  
Swamp  
Water  
Forest  
Desert  
Rough

©LETTERS 1984

For a sample flyer, write Frank Hender, c/o  
LETTERS, Suite 555, 429 W. Ohio, Chicago  
60610. Or stop by Booth 2 at Origins.



GUARANTEED FUN or your money refunded

**SPACE RACE - \$4.99**

A game of early space exploration

**THE AMERICAN INDIAN - \$3.50**

A new F.R.P. character

**MT. RAM TRIBE - \$3.50**

F.R.P. adventure for indian gold

Include \$1.00 for postage and handling  
A complete list of publications and A  
"LOOK THE PART YOU PLAY" costume brochure  
for \$1.00 (Refunded  
on your 1st order)

Also Die bags,  
Bracers & Boots



**WHO  
GOES  
THERE**



**IT IS I -  
FANTASY ROLE PLAYER!**

Identify thyself with  
exclusive FRP  
buttons. Send  
only \$2.00 per  
button today.

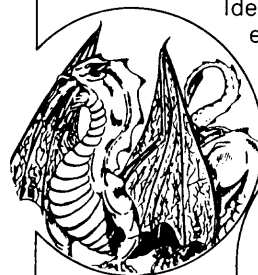

Dragon

Actual size  
2 1/4 inches

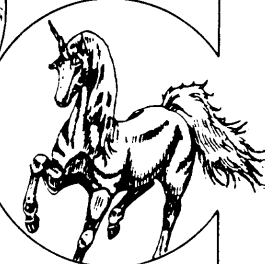

Unicorn

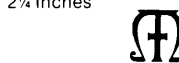

**THE MARKETPLACE**  
908 NIAGARA FALLS BOULEVARD  
NORTH TONAWANDA, NEW YORK 14120

The Gamer's Guide offers a wide  
selection of advertisements and notices  
directed specifically at the ever-growing  
audience of game hobbyists. It is a place  
for growing businesses to tell readers  
about their wares, and for the estab-  
lished business to publicize products of  
interest to gamers.

Payment for space purchased in the  
Gamer's Guide must accompany an  
advertiser's insertion order. For 2" to 5"  
of column depth (column width = 2 3/16"),  
rates are:

Per column inch	1x	6x	12x
	\$59	\$55	\$49

For further information, contact Adver-  
tising Sales Administrator, DRAGON®  
Magazine, P.O. Box 110, Lake Geneva,  
WI 53147, phone (414) 248-3625



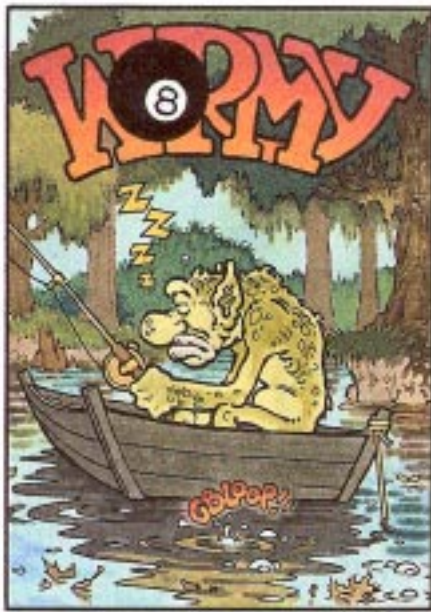



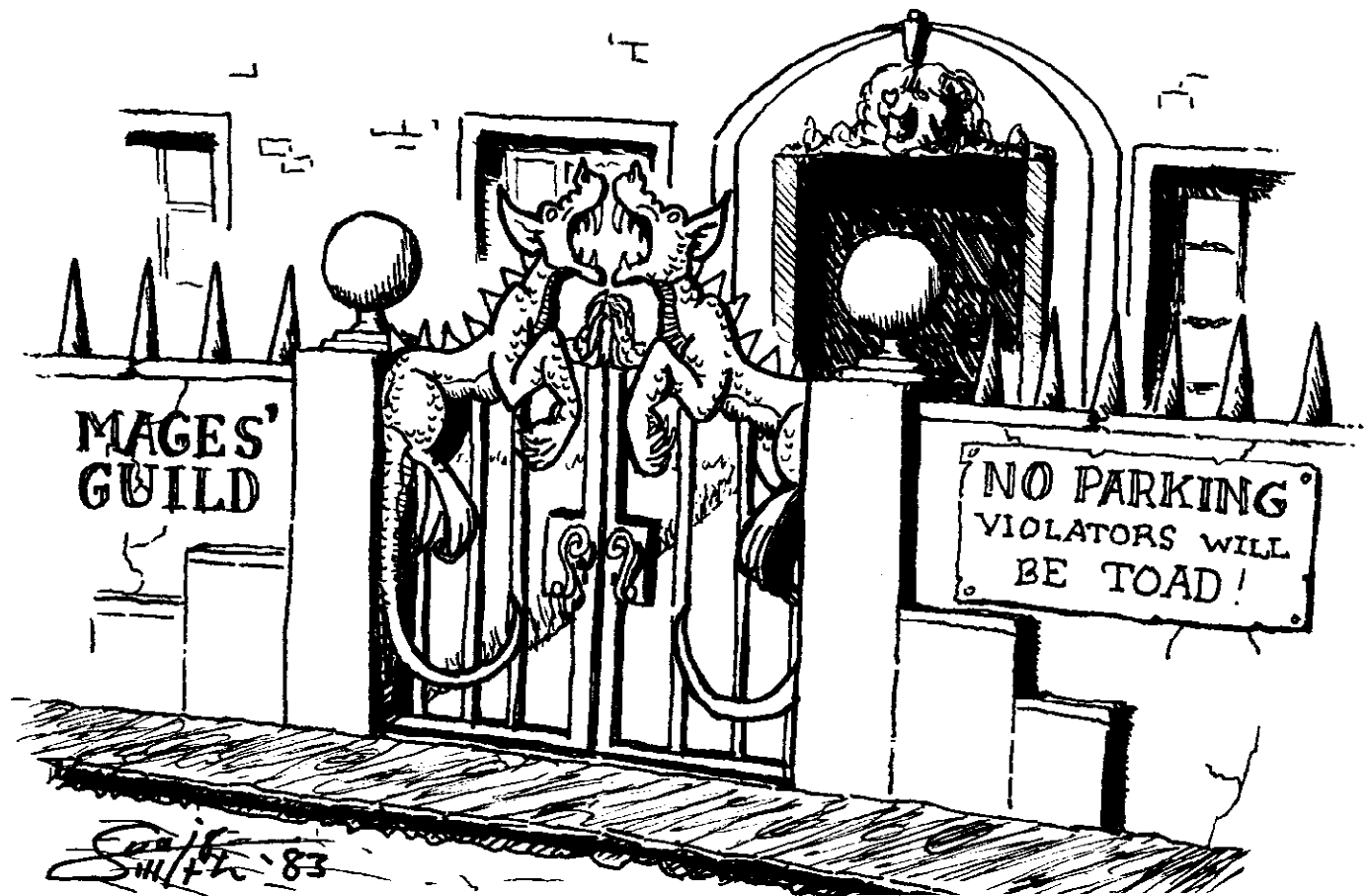

**Heroic Fantasy**

Tal Alan

Tal sets up his dungeon at a wargaming convention.

You're at the Sorcerer's door. A porter offers you a shot of novocaine before entering.

Art by Ericsson

"10:30. Talmadge Quintan, Jr. will lead a *Monsters and Misanthropes* expedition in the Armada Hotel Elkump Conference Room."

That's here. They sure gave you a crowded room, Tal.

BOOM!!

EXIT

Table 14A. This is our space.

Right next to a game of *Nuke the World*. Who planned this con, Yuhk the Nonplussed?

4 megatons on Carson City.

All set, Tal. Let's start.

NEW PLAYER CHARACTERS

WARGAMES

Okay. Snierokk the Sniveler: you're outside *Castle Dunderslush* and you find a tunnel entrance.

We go in.

12 megatons on Klamath Falls.

You drop into a dark Third Level tunnel. There's a terrible noise ahead, coming straight at you...

**ROAR**

DOOM UNDER PUMPER SLASH

... Suddenly the Pentagon is besieged by 10,000 Orcs mounted on dragons.

... a squadron of SAC bombers??

Hey, give those back! I was gonna wipe out Pocatello!

Yeah! And take back your Orcs before they get into the missiles!

SUDDEN DEATH FROM THE SKIES

WARGAMES



# SNARFQUEST

# 11

BY ELMORE





OH GAAA... DAT WAS RAFF... SUTHAZE HAD TURNED HIM INTO A BUG!



SPEAK TO ME, RAFF, OL' BUDDY!

WHAT TH' @\*★!☺ IS GOIN' ON!

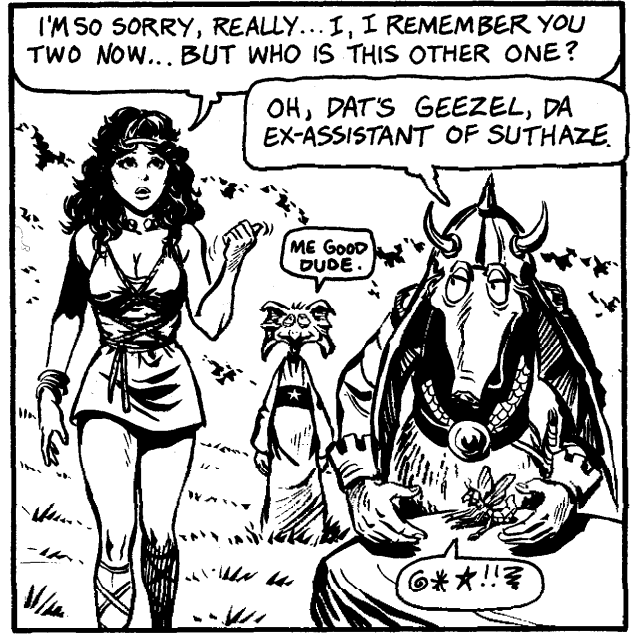

I'M SO SORRY, REALLY... I, I REMEMBER YOU TWO NOW... BUT WHO IS THIS OTHER ONE?

OH, DAT'S GEEZEL, DA EX-ASSISTANT OF SUTHAZE.

ME GOOD DUDE.

@\*★!☺



CHECK DIS OUT, WE DIDN'T KNOW WHICH WAND WAS YOURS, SO, WE GOT 'EM ALL.



OH MY-MY... THIS IS WONDERFUL... OOOHH!

YEAH, AN' ME HELPED 'EM GET DOSE WANDS TOO.



HERE IT IS... MY WAND!!

MY BEAUTIFUL WAND!

I THANK ALL OF YOU SO VERY MUCH!



NOW OUR WISHES... REMEMBER? YOU MADE A DEAL.

YES, I REMEMBER.

ME FIRST! ME FIRST!

NOW, LET ME CAST THE SPELL. (MUMBLE-MUMBLE)



OK... THE SPELL IS CAST, MAKE YOUR WISH.

OH WOW! I WISH THAT I WAS BACK TO MY ORIGINAL SELF!



POOF!





# BUG-EYED MONSTERS

## They Want Our Women!

On silent grav sleds, the alien creatures slide through the forest, readying their lasers and stunners, drooling slightly in anticipation. They choose their first target: a little clapboard house nestled in the woods above town. They attack. The sounds of lasers and stunners are soon met by cries of fear and rage. Wild with lust, they fail to notice when one human makes it to a car and careens away to rouse the citizenry of the small town against the alien threat.

Ugly, slobbering, bug-eyed monsters! They land in remote American towns and make off with women.

BUG-EYED MONSTERS is the new West End release by Greg Costikyan, designer of the successful *Creature That Ate Sheboygan*.<sup>TM</sup> In this game, Greg returns to the "Creature" genre, bringing a flying saucer with menacing monsters to the quiet remote American town of Freedom, New Hampshire.

One player, as the monster, must attempt to kidnap the earthling women (the most beautiful in the universe). The other player must rally the citizens of the town to

stop the repulsive invaders and save his womenfolk from a fate worse than death.

A special "Aliens Kidnap Presidential Hopeful" scenario is also provided. Dwight Eisenhower, campaigning for the New Hampshire primary, along with an entourage of state troopers and secret service men, is surprised by a party of bug-eyed monsters. Will they kidnap America's war hero?

A simple but elegant game system with clear brief rules makes BUG-EYED MONSTERS a good introduction to adventure gaming, but its subject and smooth play will appeal to the hardcore gamer as well.

### THE DESIGNER

Greg Costikyan is the designer of nine published games, including THE CREATURE THAT ATE SHEBOYGAN,<sup>TM</sup> SWORDS AND SORCERY,<sup>SM</sup> DEATH MAZE,<sup>SM</sup> RETURN OF THE STAINLESS STEEL RAT,<sup>SM</sup> and TRAIL BLAZER.<sup>SM</sup>

The above titles are all the trademarks of TSR Inc. with the exception of TRAIL BLAZER which is the trademark of Metagaming.

- one 22" x 17" game map
- 160 full-color, back-printed precision die cut 5/8" counters.
- one 8-page rules booklet
- two dice and full-color game box (1" wide bookshelf size box)

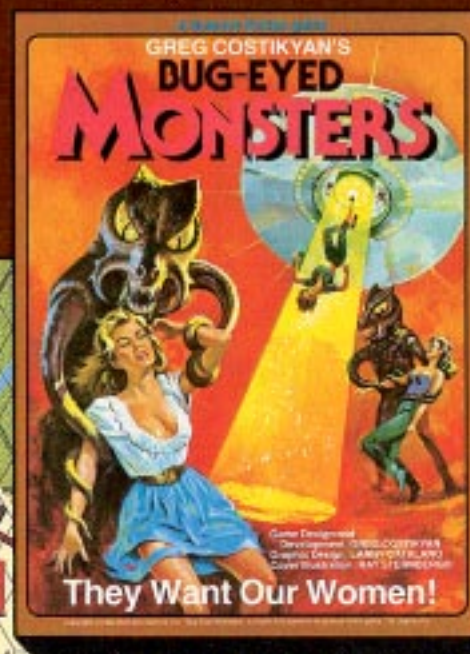

**Complexity:** Low  
**Solitaire Suitability:** Low  
**Players:** Two  
**Game Scale:** Individual Person  
**Playing Time:** An hour or less for experienced gamers



# MIDDLE-EARTH ROLE PLAYING™

a complete system for adventuring in

J.R.R. TOLKIEN'S WORLD from...



Based on THE HOBBIT™ & THE LORD OF THE RINGS™, MIDDLE-EARTH ROLE PLAYING is perfect for seasoned players as well as those who have never experienced the thrill of fantasy role playing. Produced and distributed by IRON CROWN ENTERPRISES, INC.

©1984 TOLKIEN ENTERPRISES, a division of ELAN MERCHANDISING, Berkeley, CA. No unauthorized use permitted.



MIDDLE-EARTH ROLE PLAYING is supported by the CAMPAIGN & ADVENTURE GUIDEBOOK (not pictured), a line of campaign modules and a line of adventure modules including BREE and the Barrow Downs. MIDDLE-EARTH ROLE PLAYING (U.S. \$8.00 in book form, U.S. \$12.00 for the boxed edition) is sold at better stores *everywhere*. Dealer inquiries welcome. IRON CROWN ENTERPRISES/P.O. BOX 1605/CHARLOTTESVILLE, VA 22902